

かきかた 5かく

①②③④⑤のじゅんばんで
かきましょう

ひらがな
の
れんしゅう
を
しよびょう。

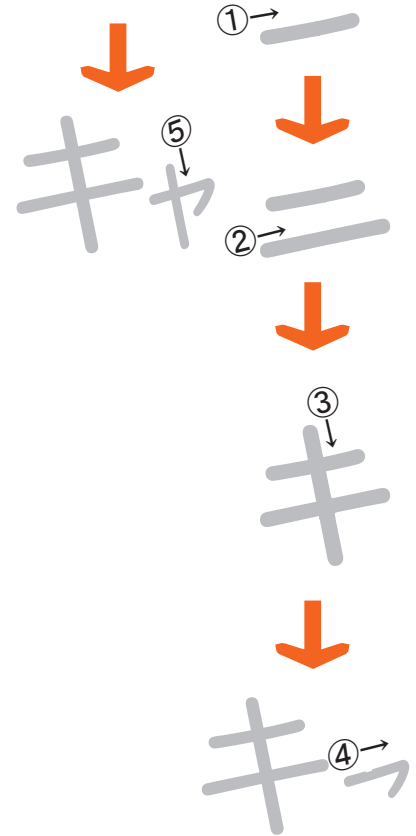

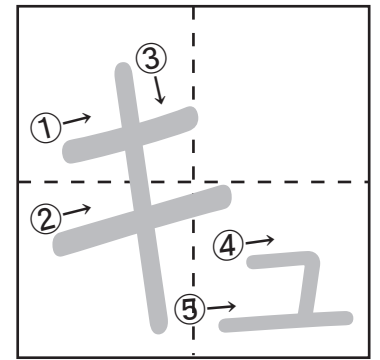
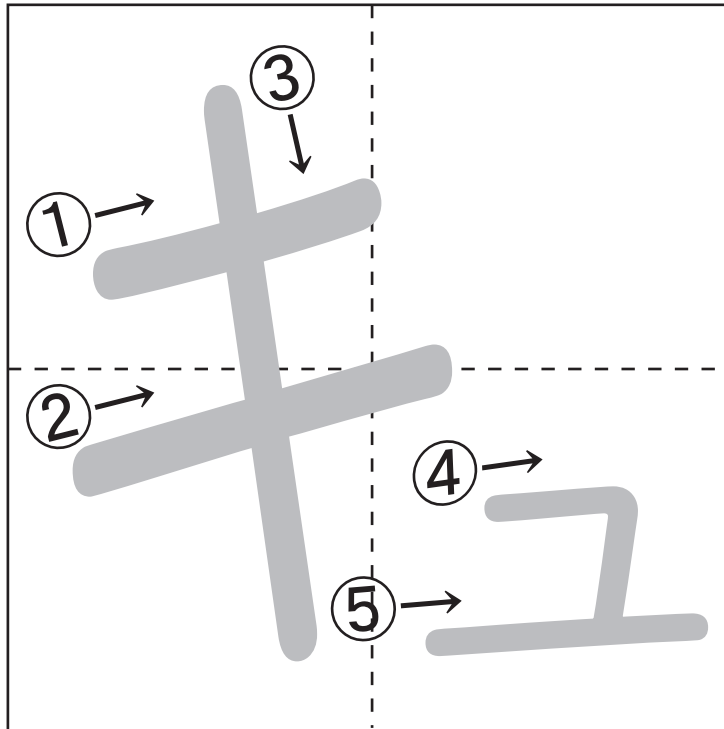
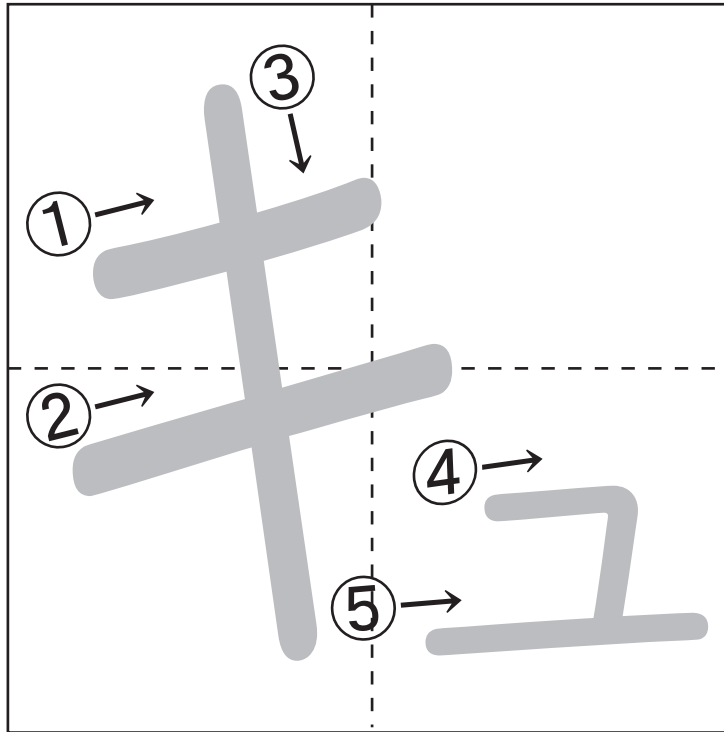
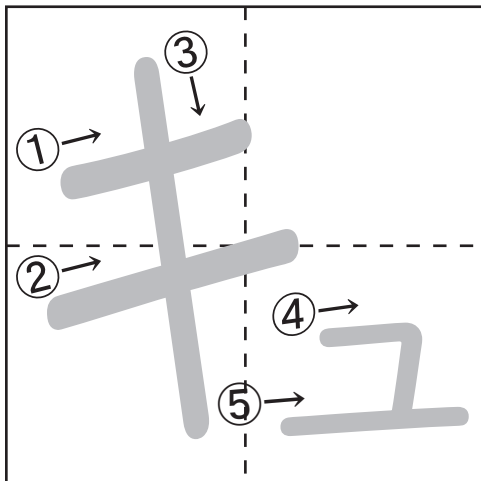
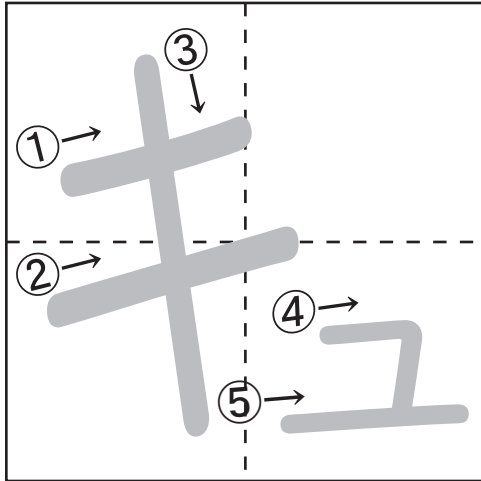
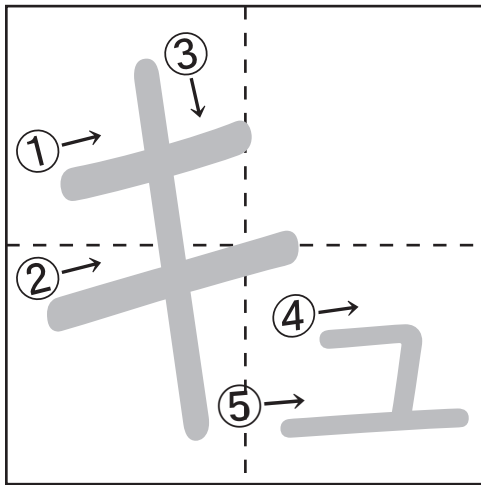
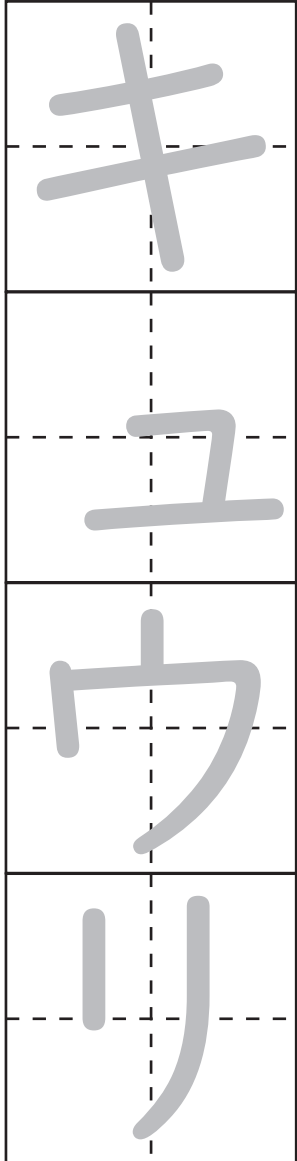
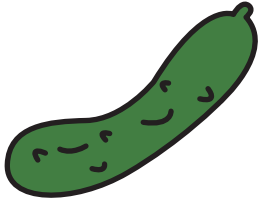

かきかた 5かく

①②③④⑤のじゅんばんで
かきましょう

ひらがな
の
れんしゅう
を
しよびょう。

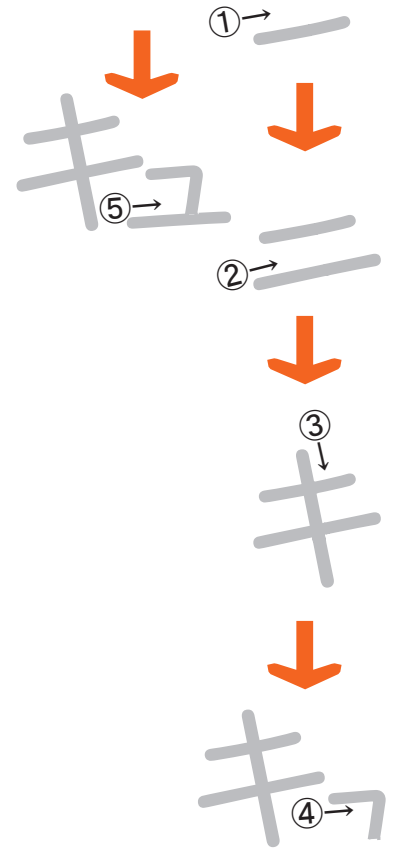

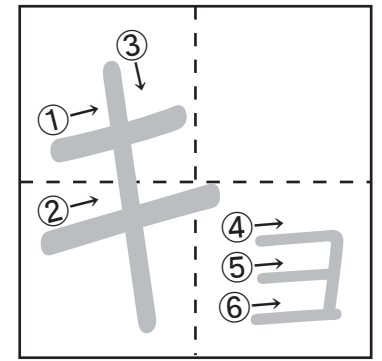
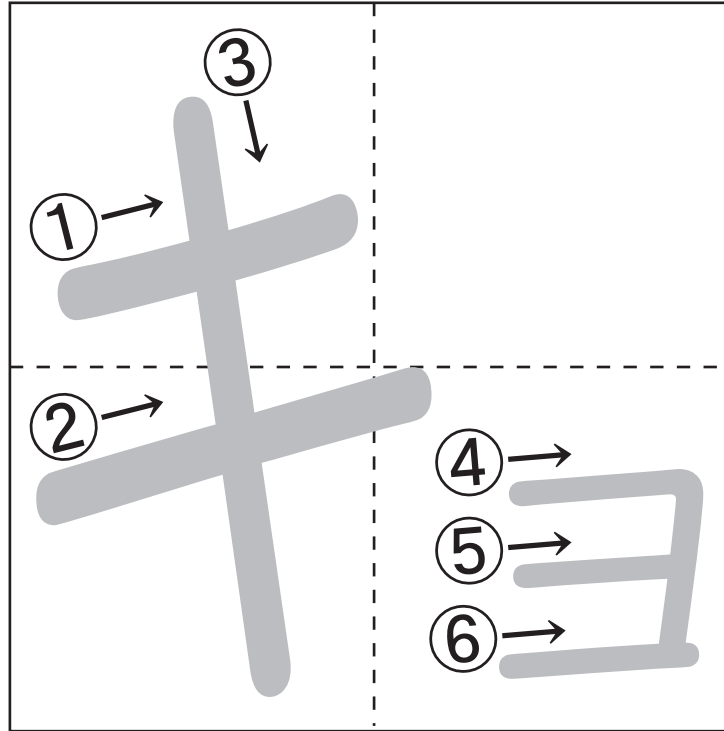
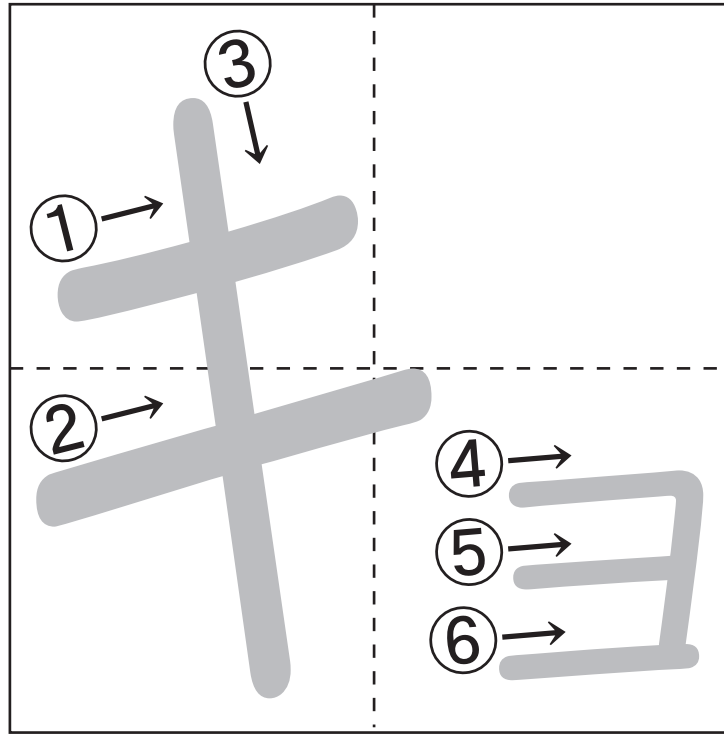
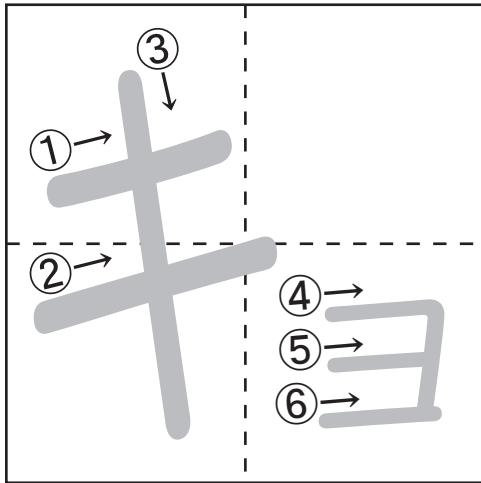
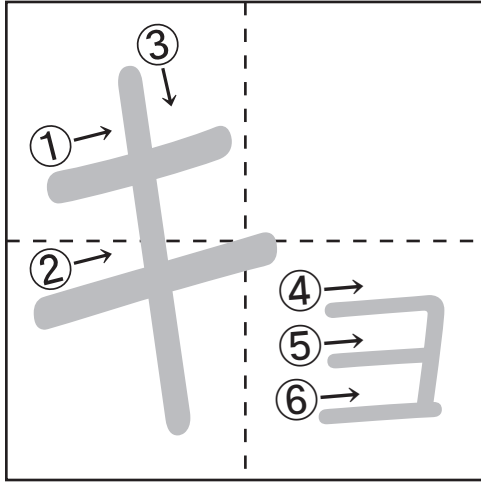
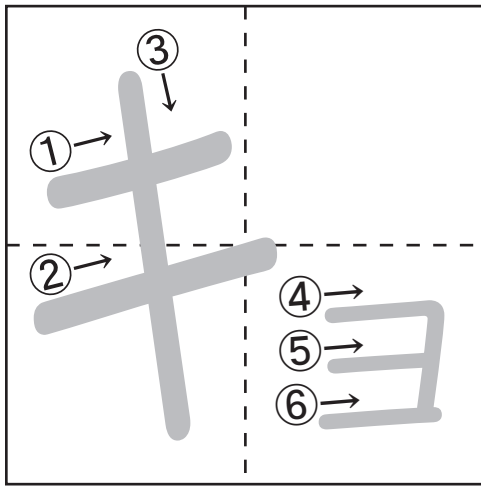
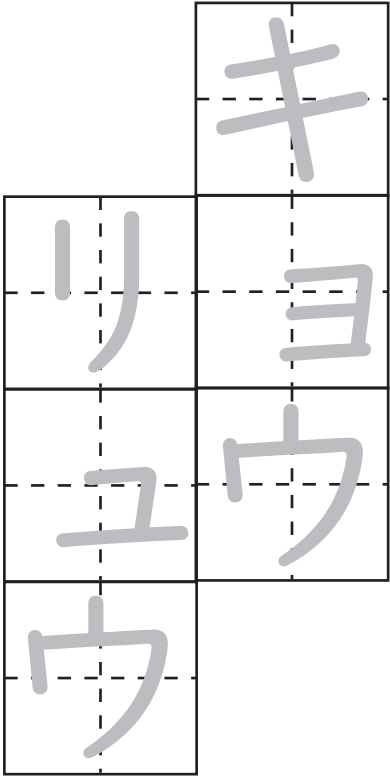
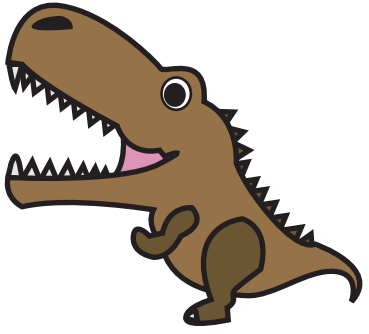

かきかた 6かく
①②③④⑤⑥のじゅんばん
でかきましょう

ひらがな

の

れんしゅう

を

しゅう。

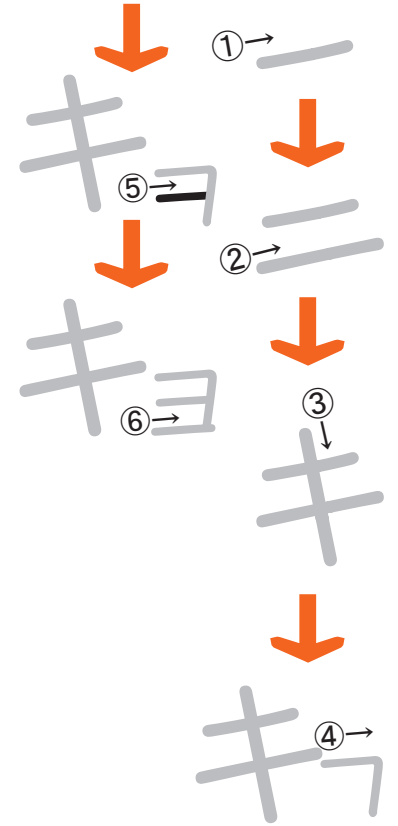

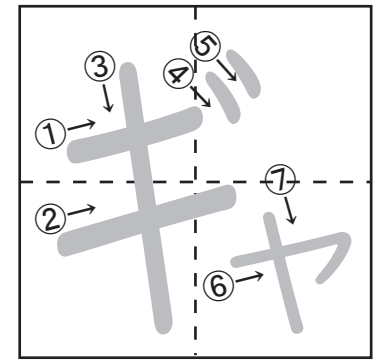
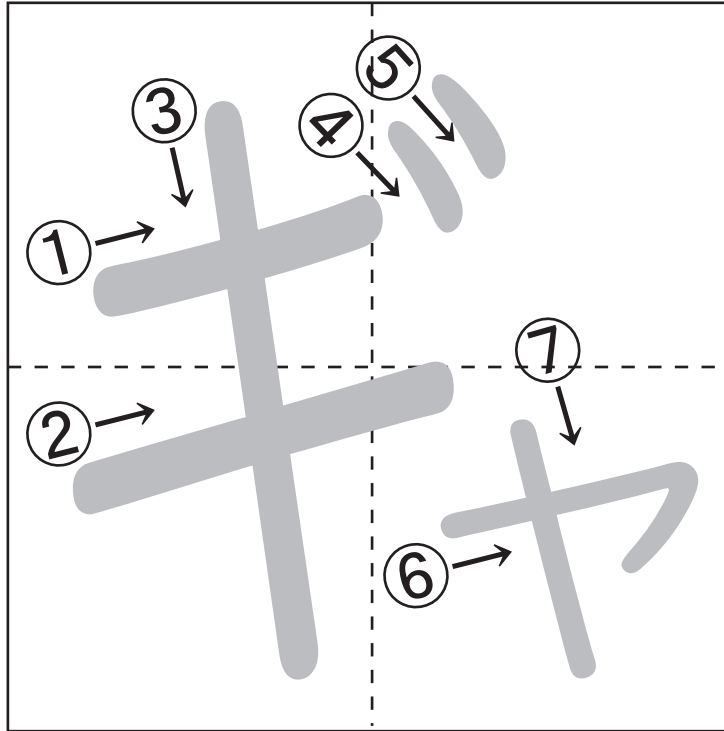
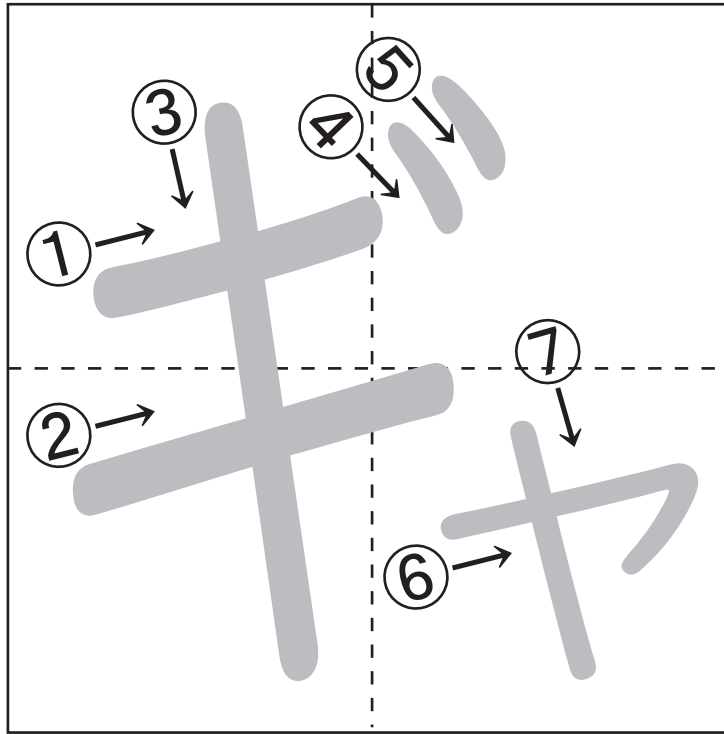
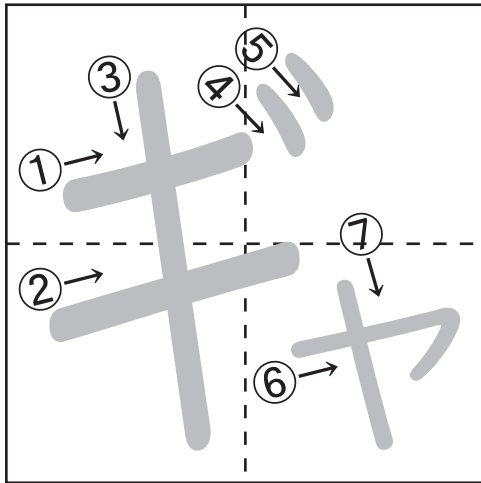
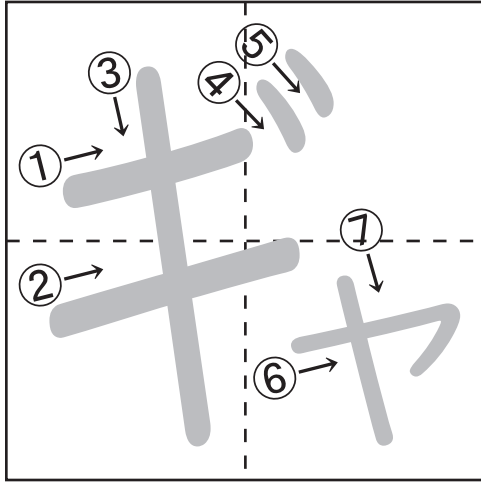
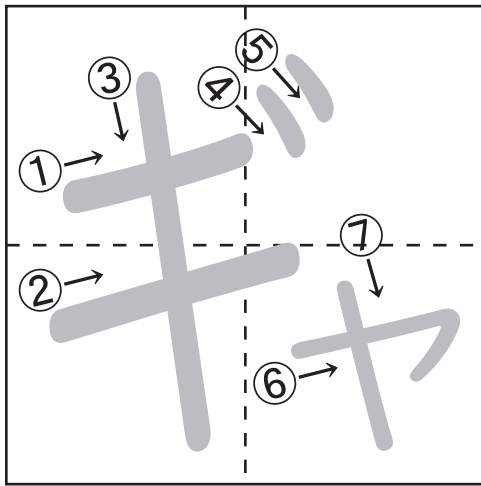
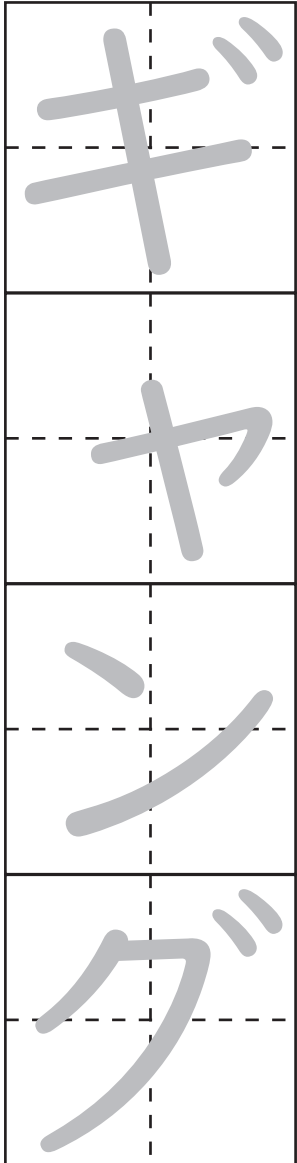

かきかた 5かく

①②③④⑤⑥⑦の
じゅんばんでかきましょう

ひらがなの
れんしゅう
をしゅう。

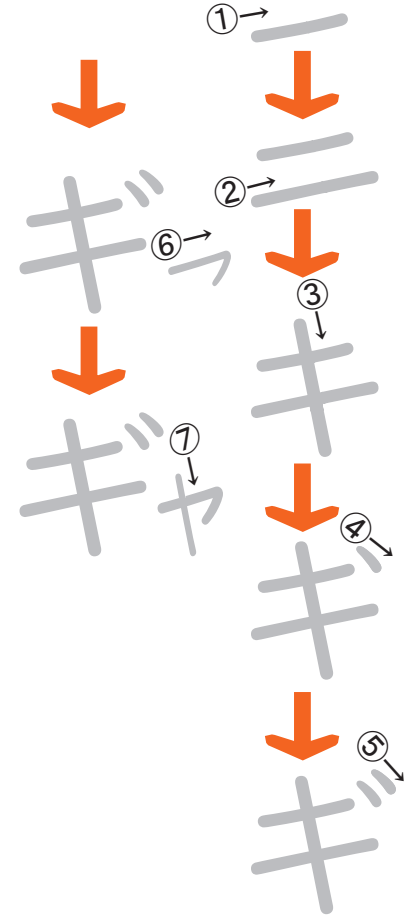

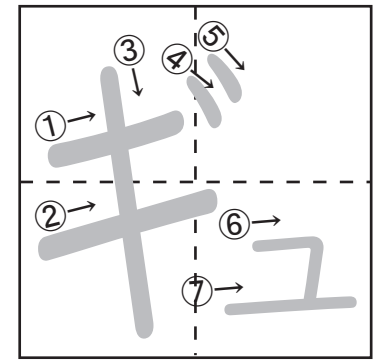
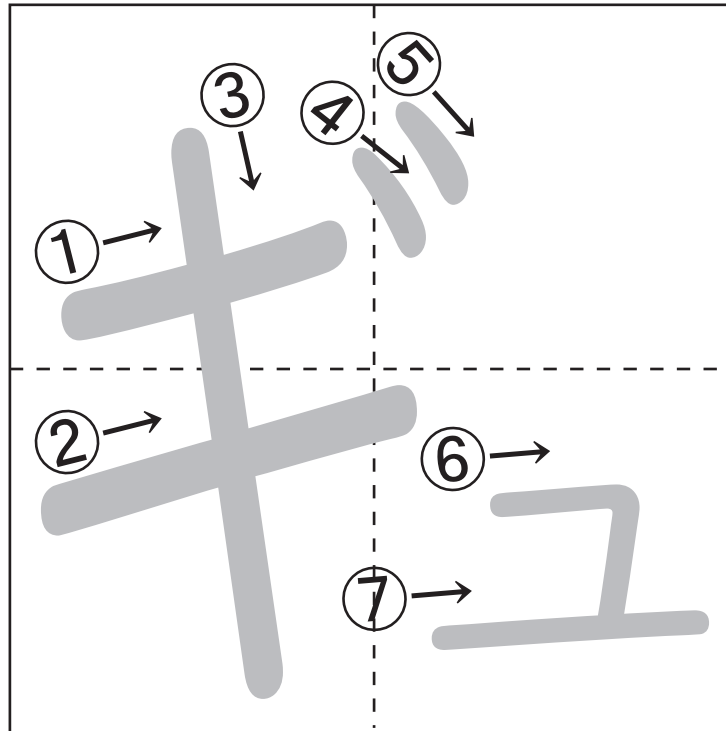
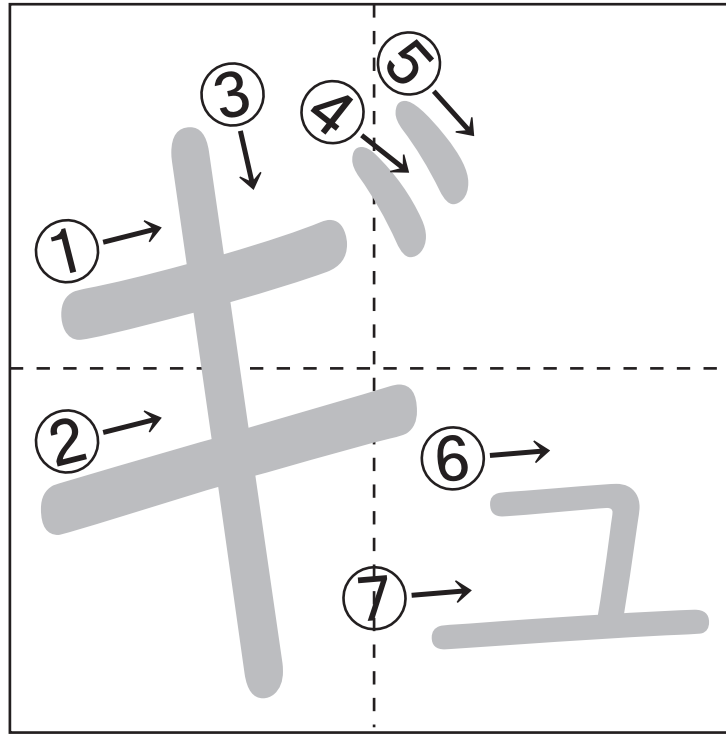
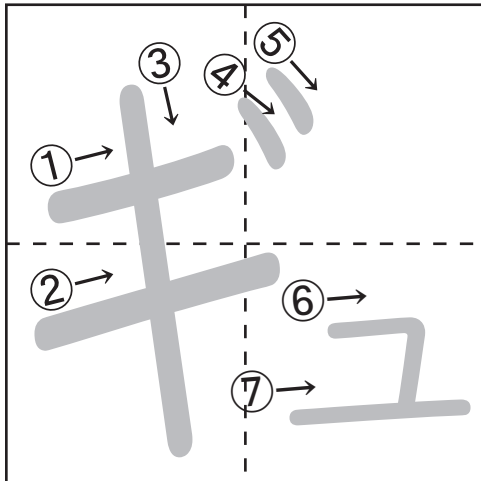
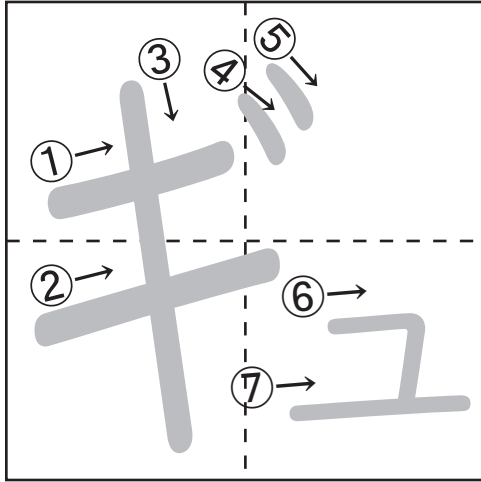
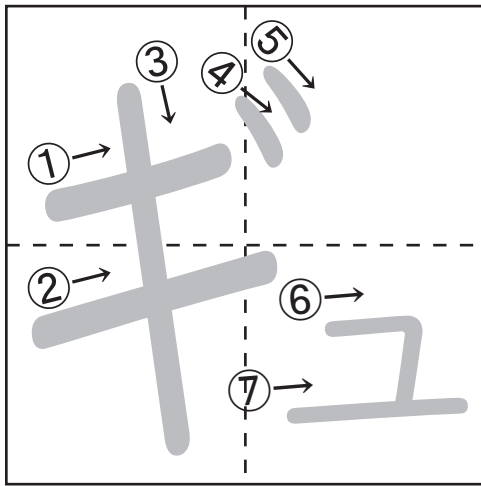
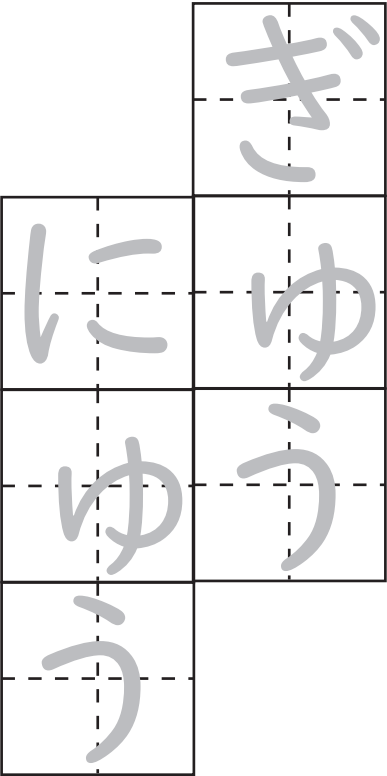
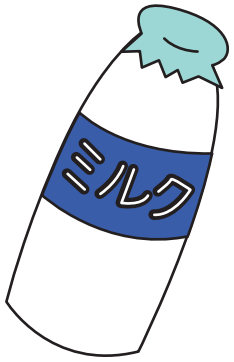

かきかた 5かく

①②③④⑤⑥⑦の
じゅんばんでかきましょう

ひらがな
の
れんしゅう
を
しよう。

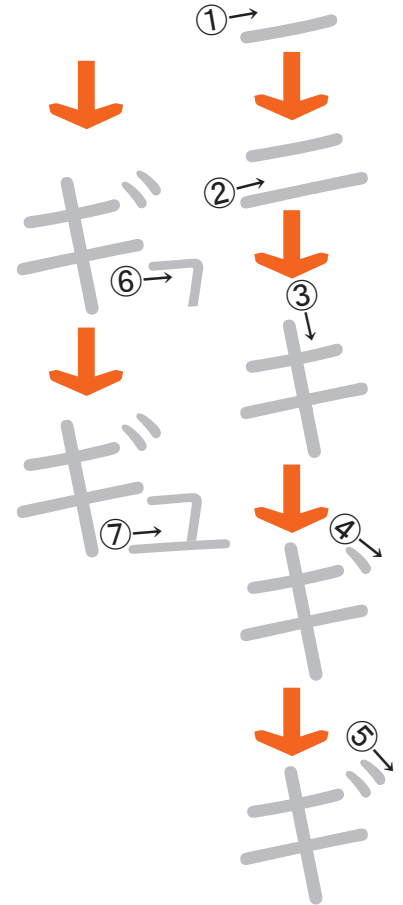

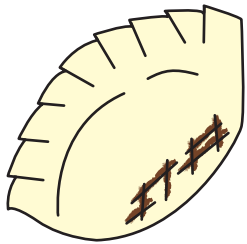

ギ
ヨ
ウ
ザ

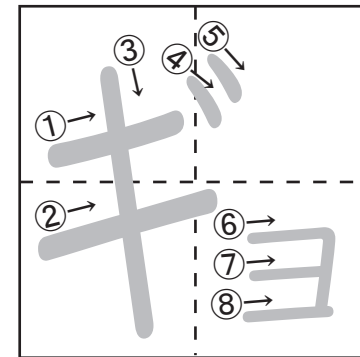
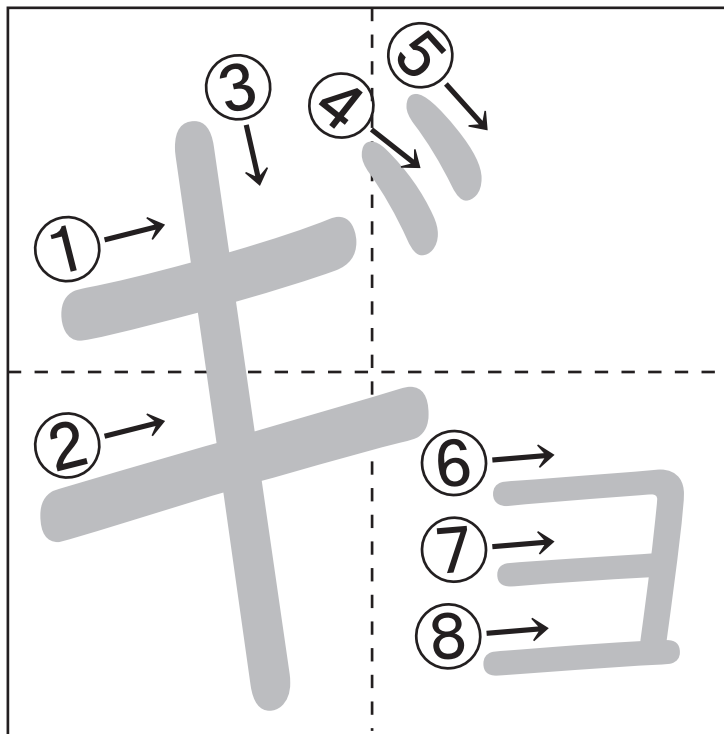
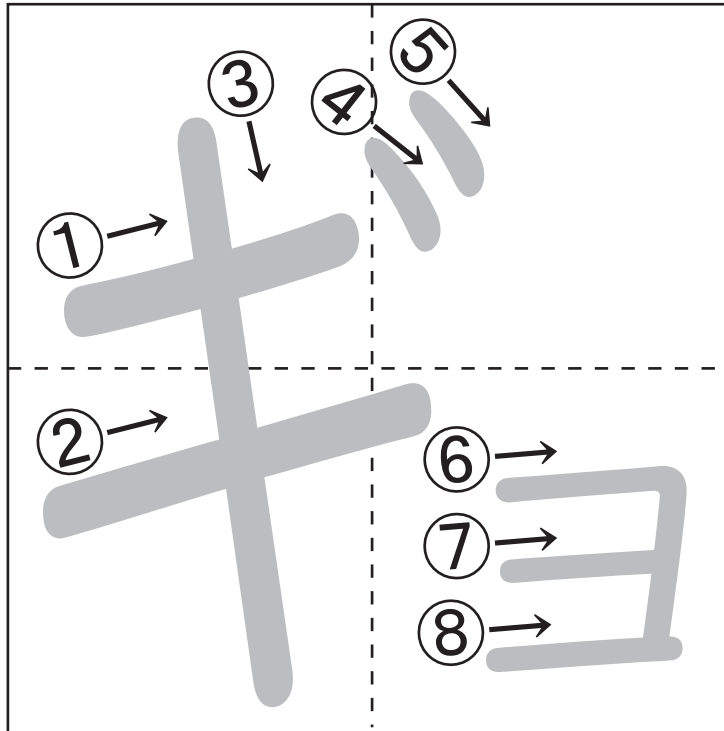
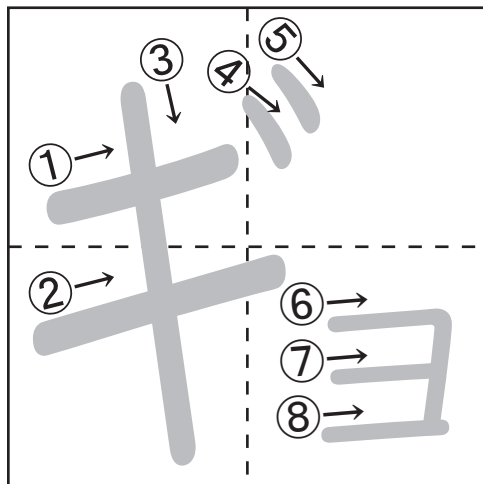
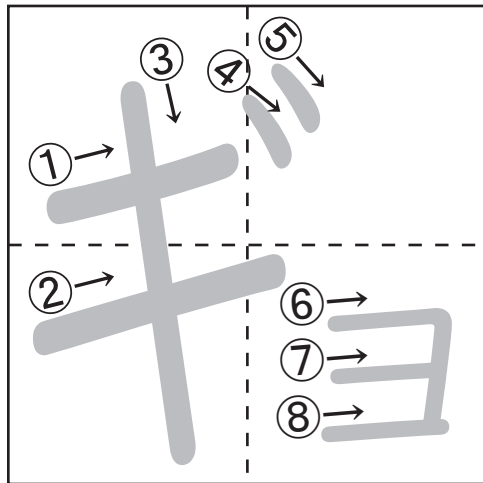
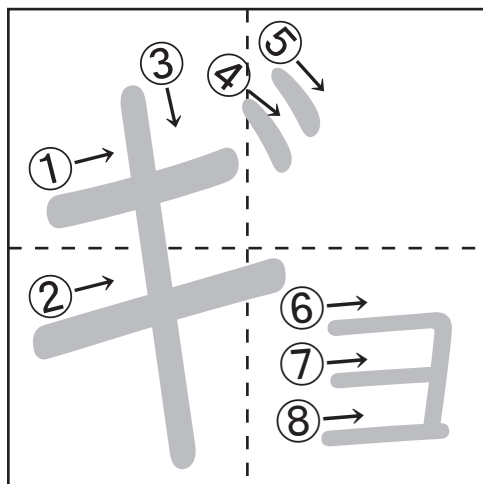

かきかた 8かく

①②③④⑤⑥⑦⑧の
じゅんばんでかきましょう

ひらがな

の

れんしゅう

を

しゅりゅう。

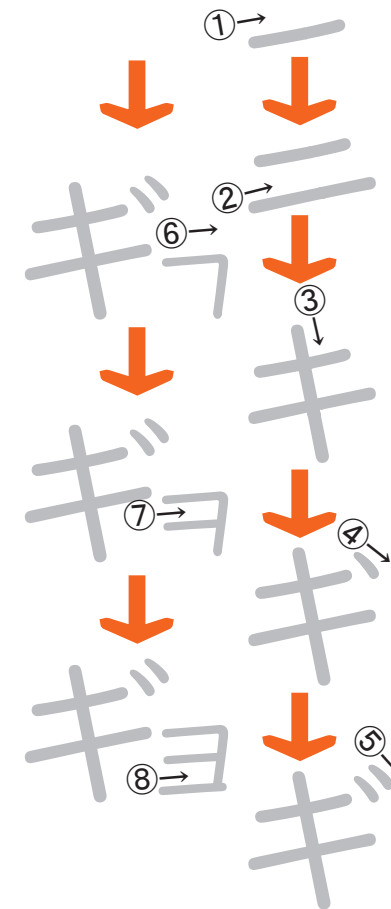

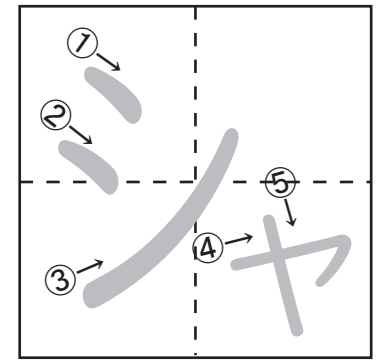
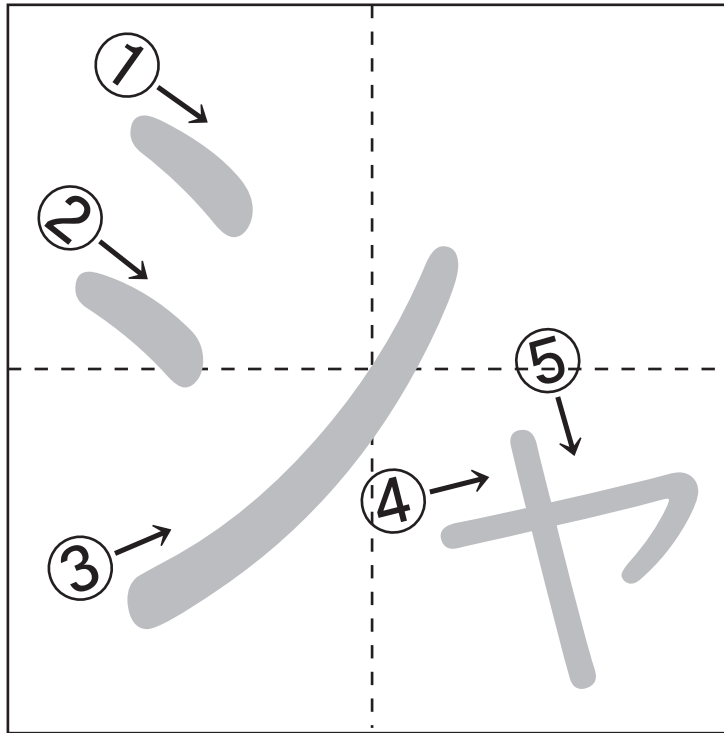
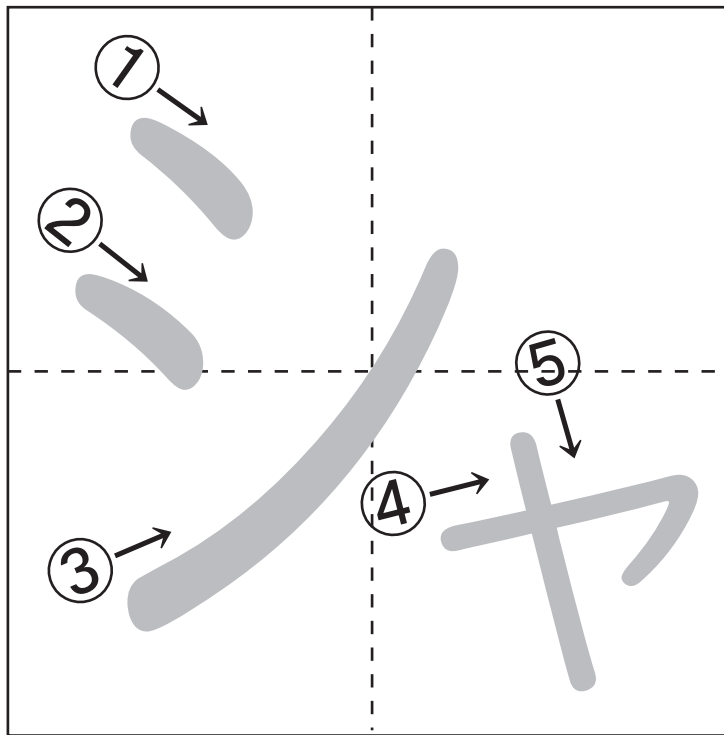
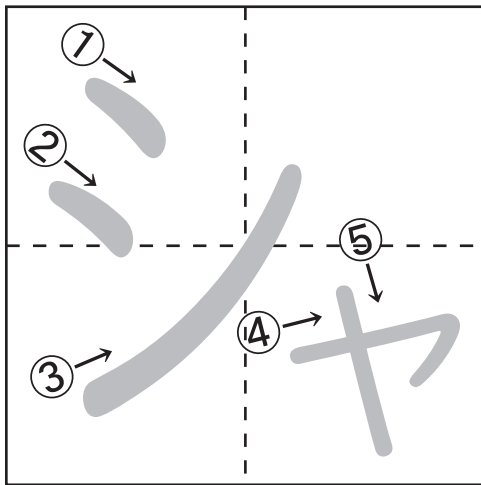
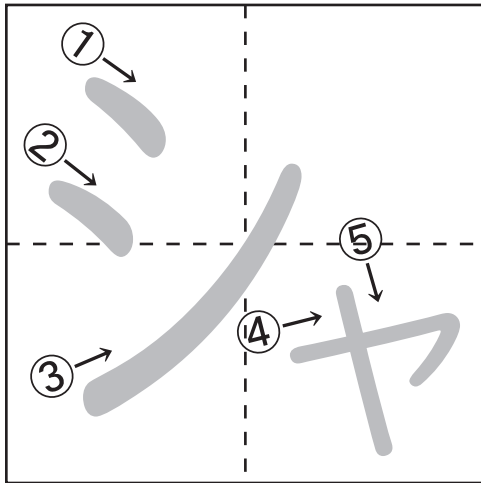
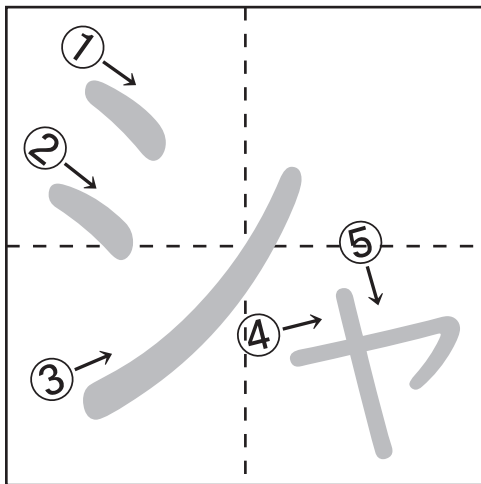
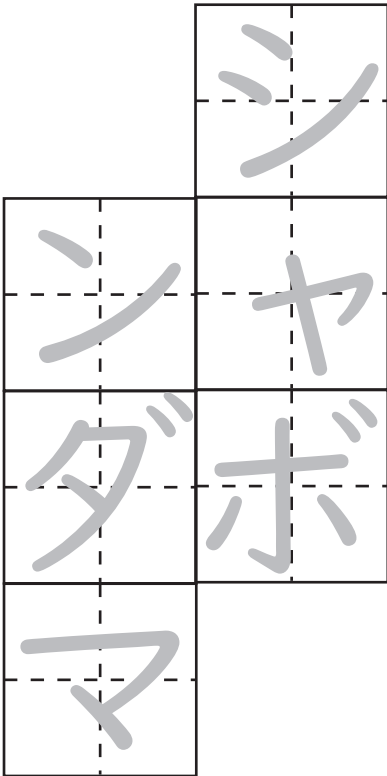
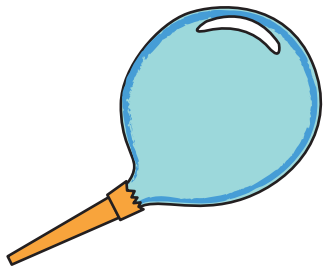

かきかた 5かく

①②③④⑤⑥⑦の
じゅんばんでかきましょう

ひらがなの
れんしゅうを
しよう。

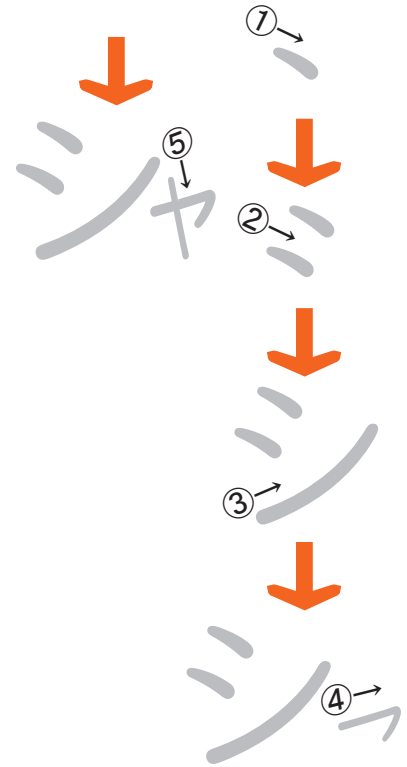

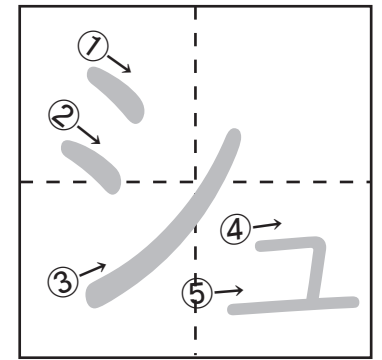
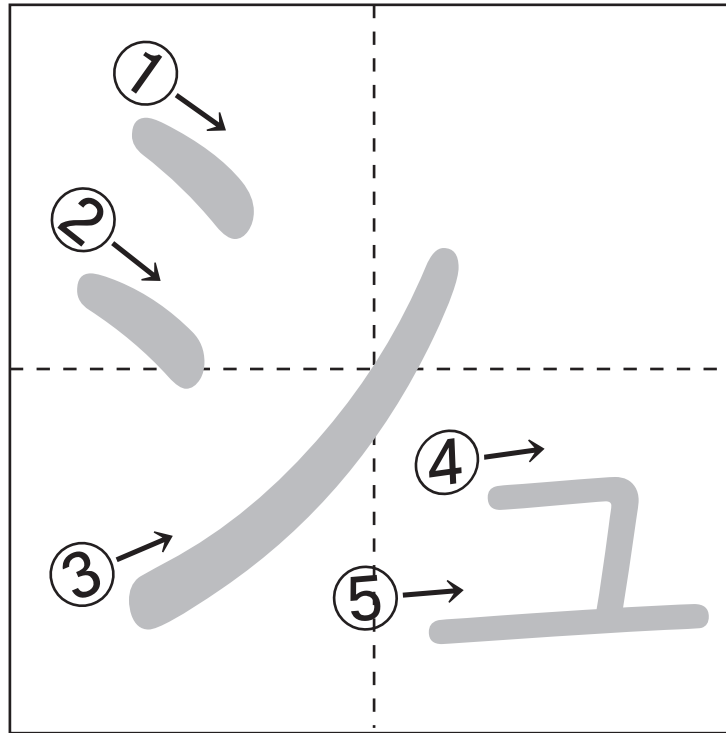
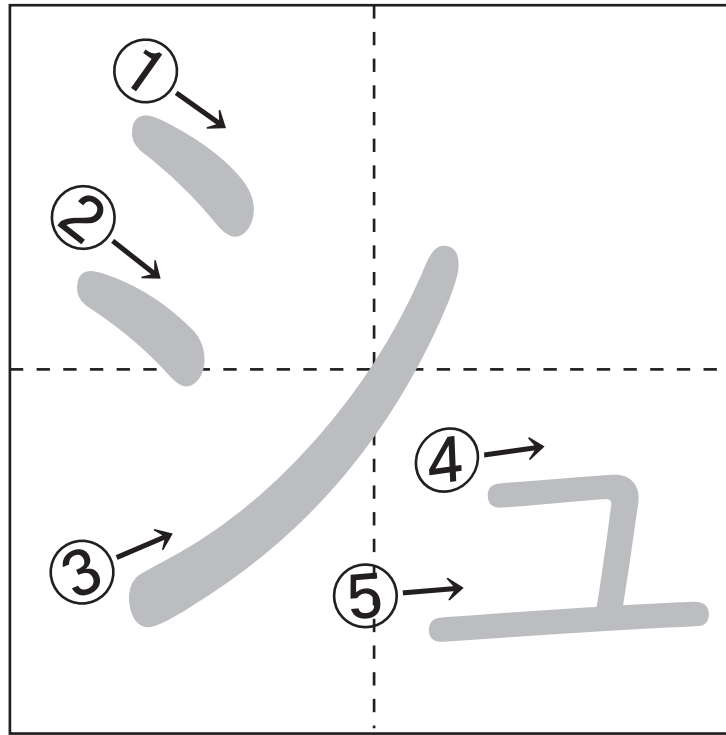
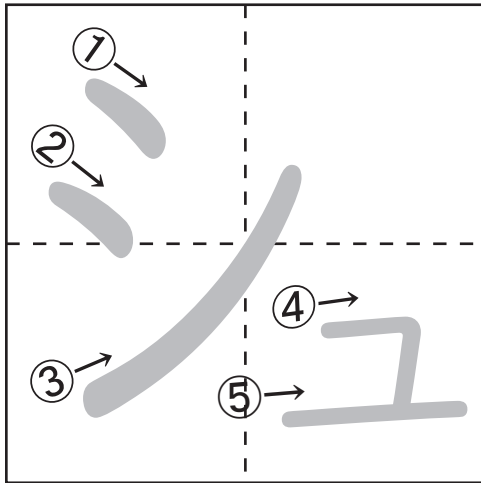
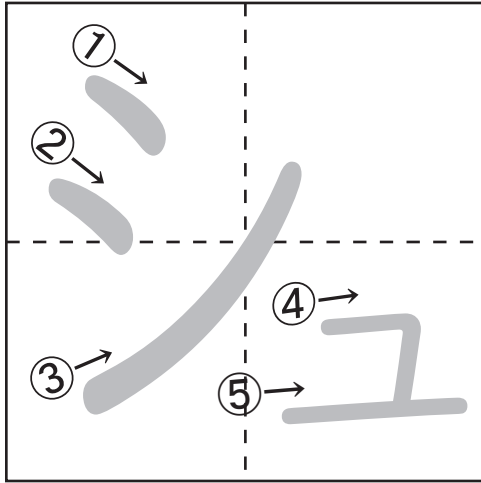
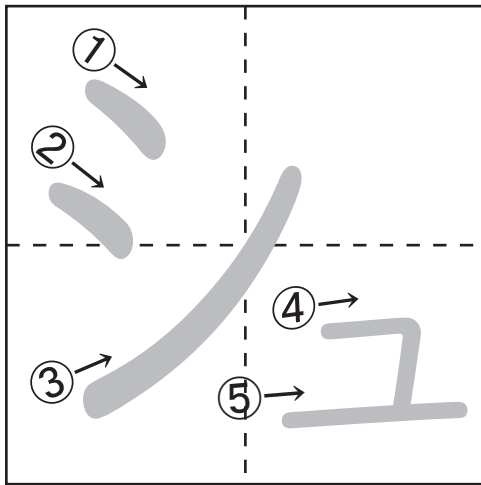
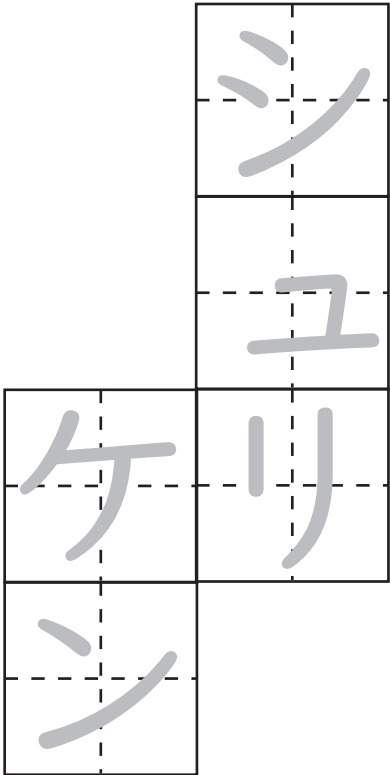

かきかた 5かく

①②③④⑤のじゅんばんで
かきましょう

ひらがな
の
れんしゅう
を
しよ。。

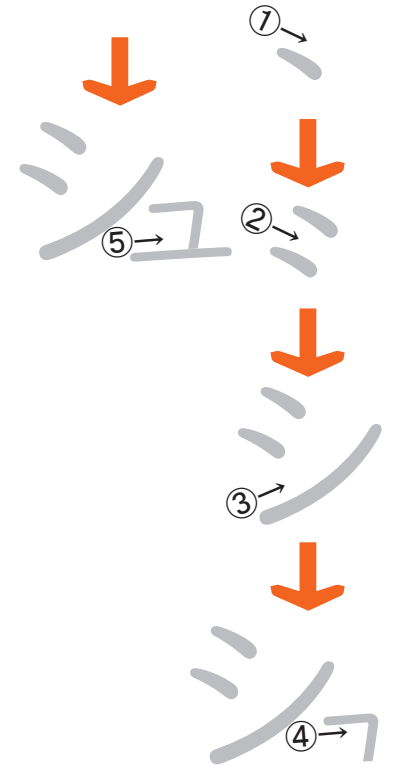

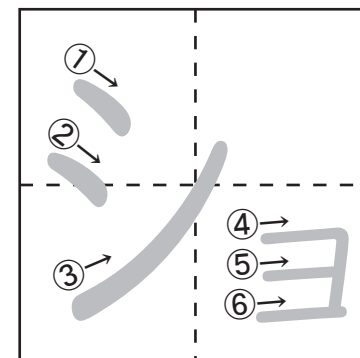
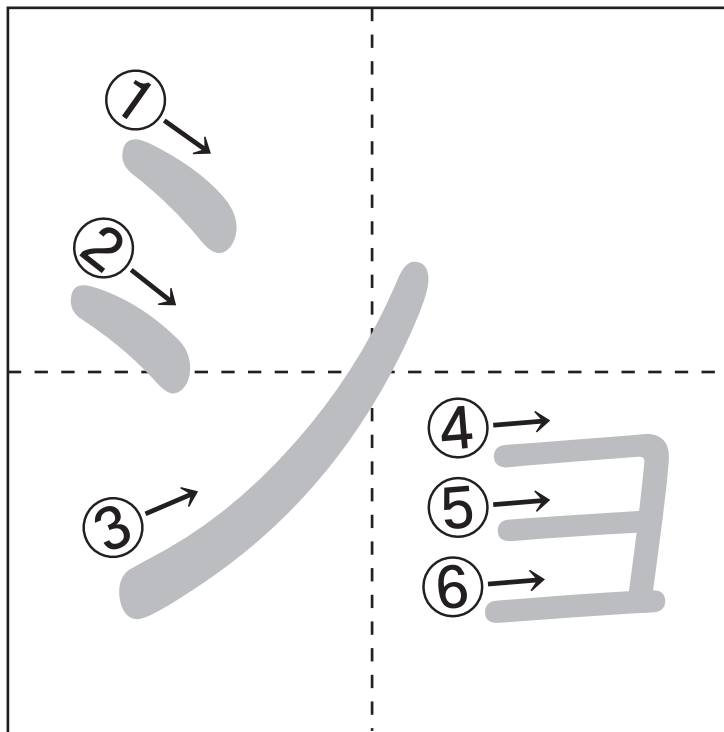
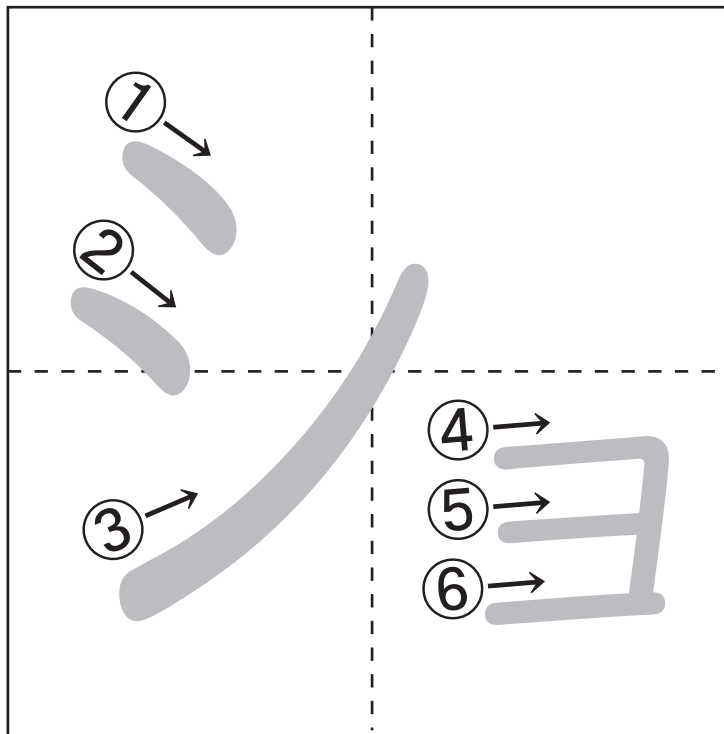
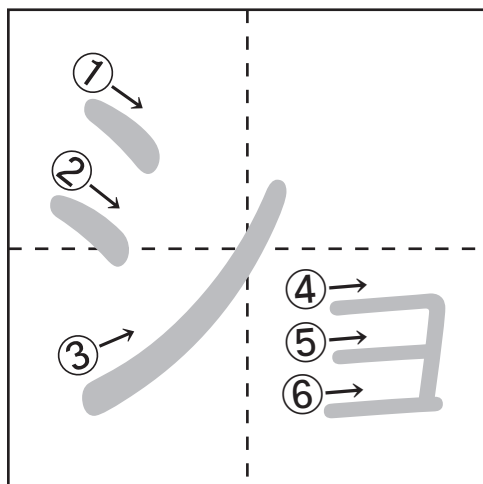
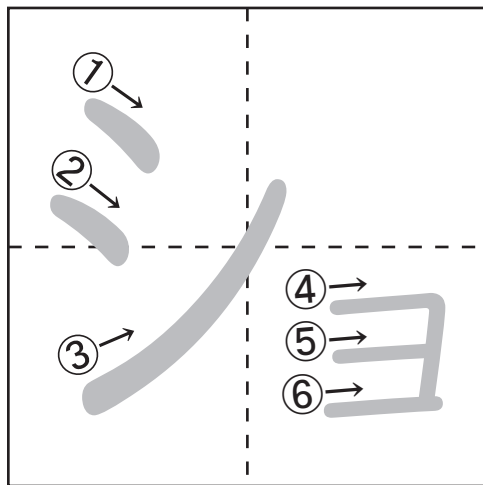
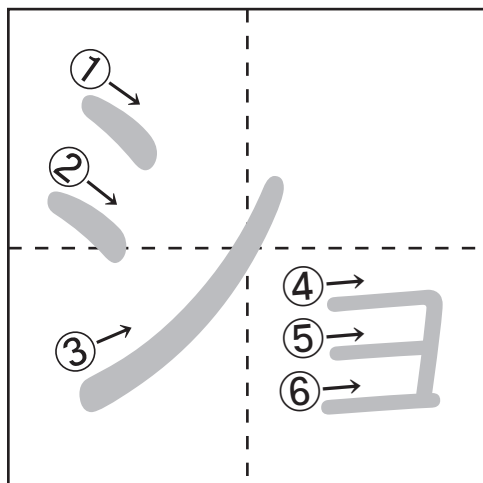
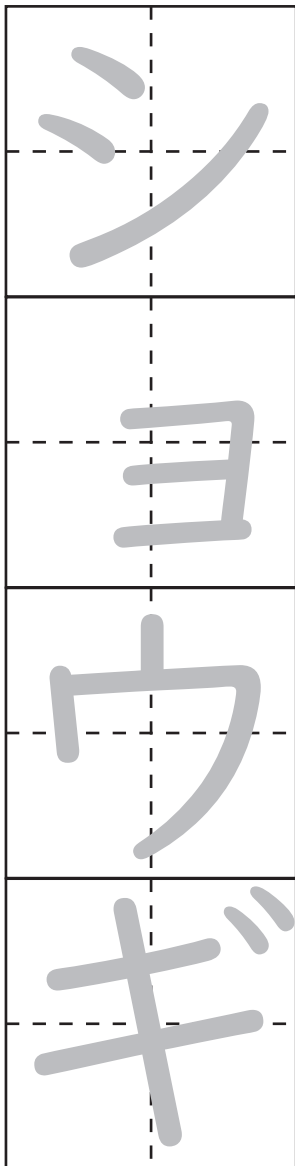

かきかた 6かく
①②③④⑤⑥のじゅんばん
でかきましょう

ひらがな
の
れんしゅう
を
しよび。

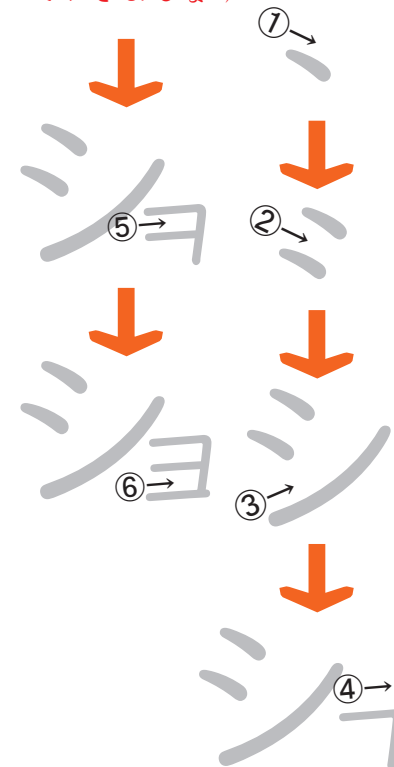

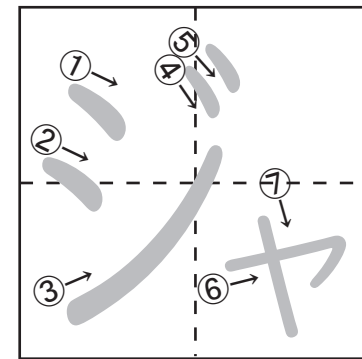
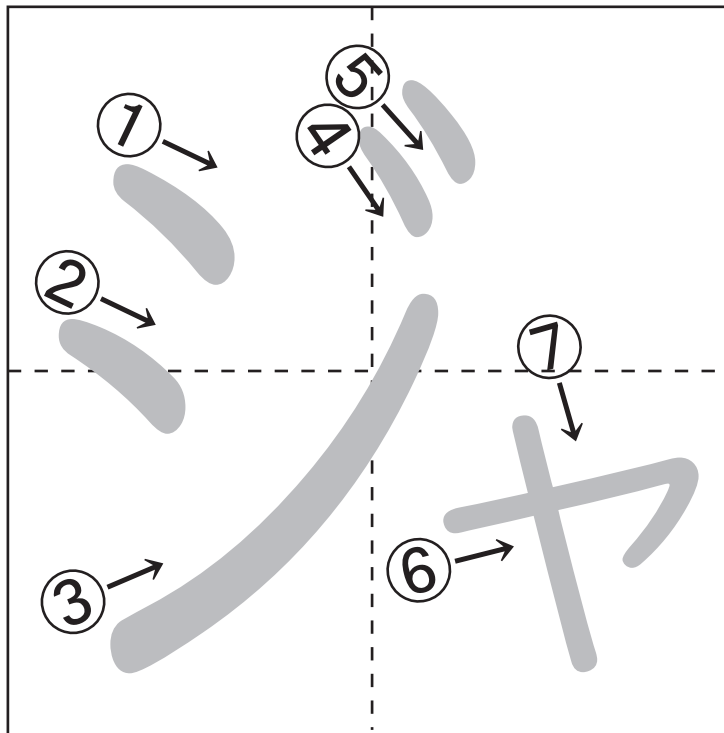
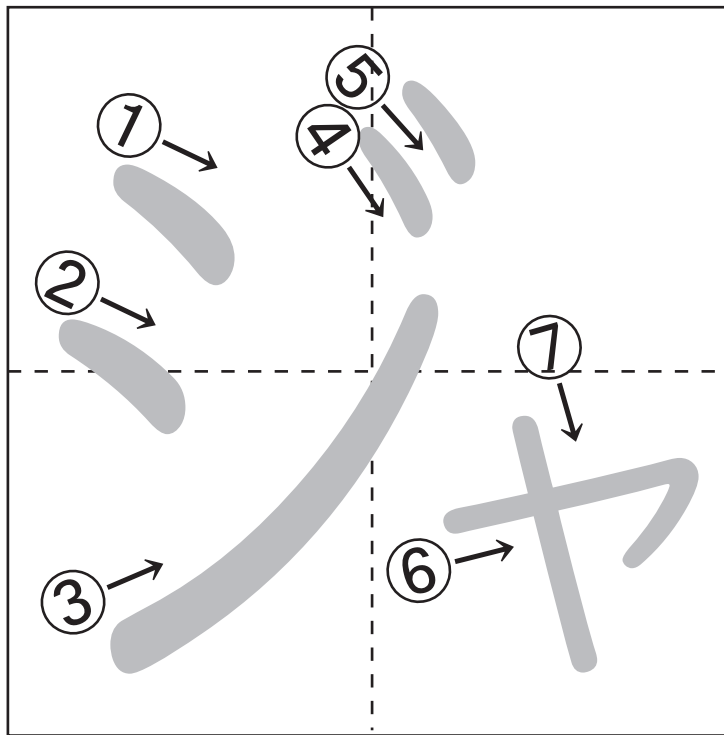
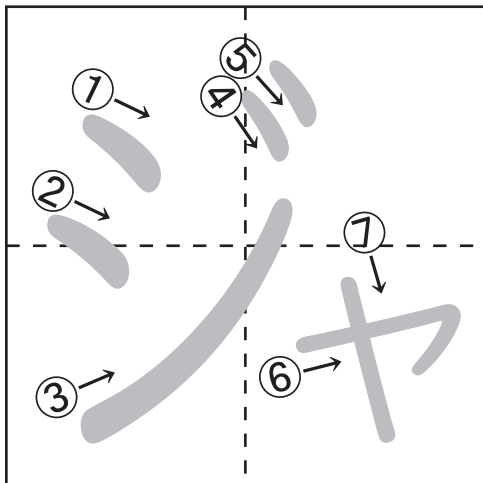
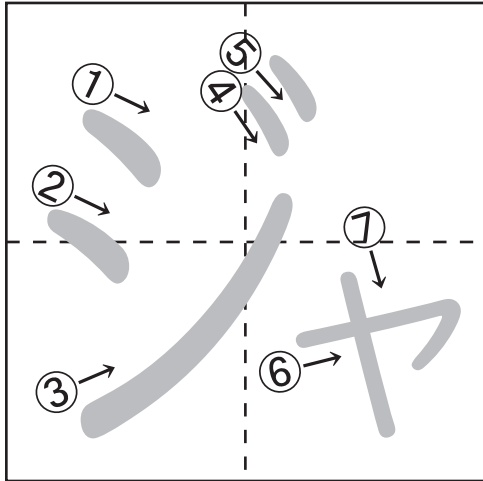
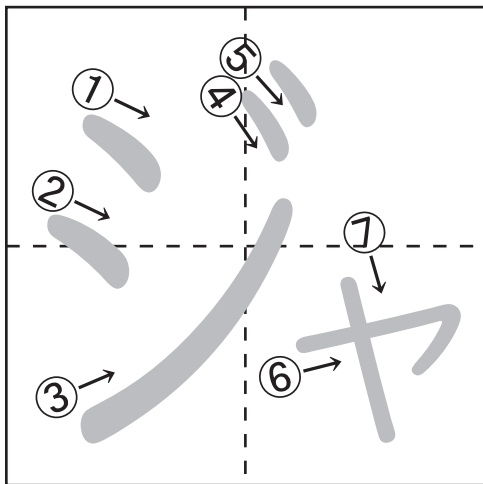
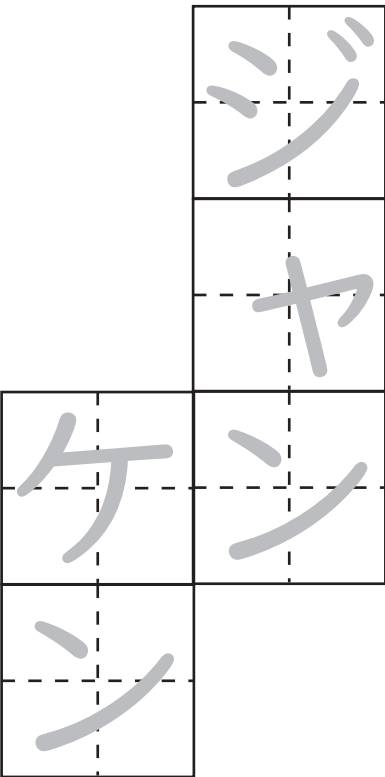
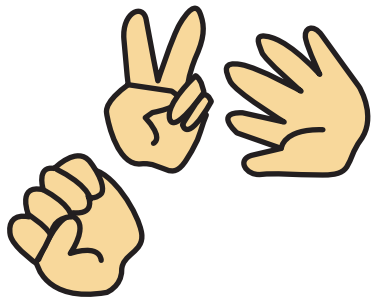

かきかた 7かく

①②③④⑤⑥⑦の
じゅんばんでかきましょう

ひらがなの
れんしゅう
をしゅう。
を しゅう。

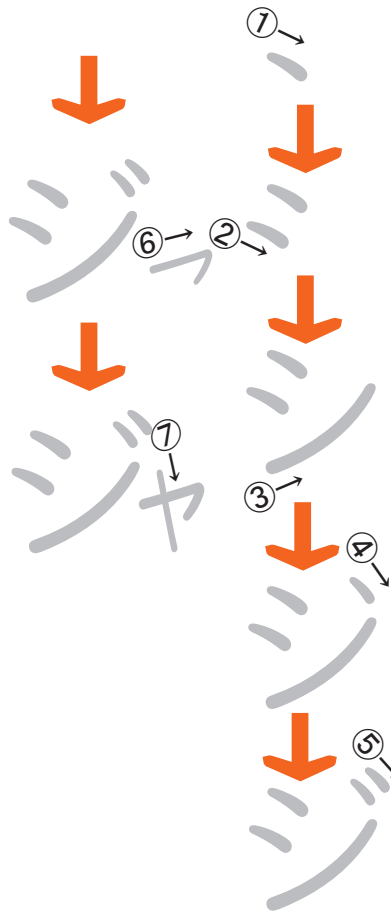

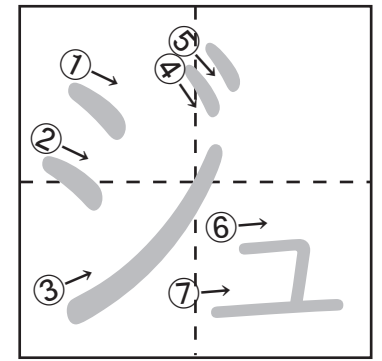
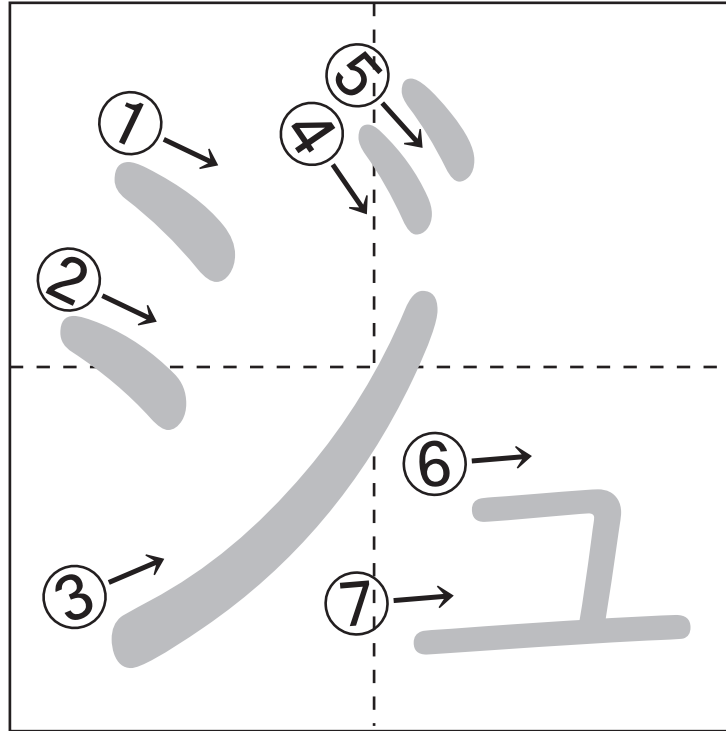
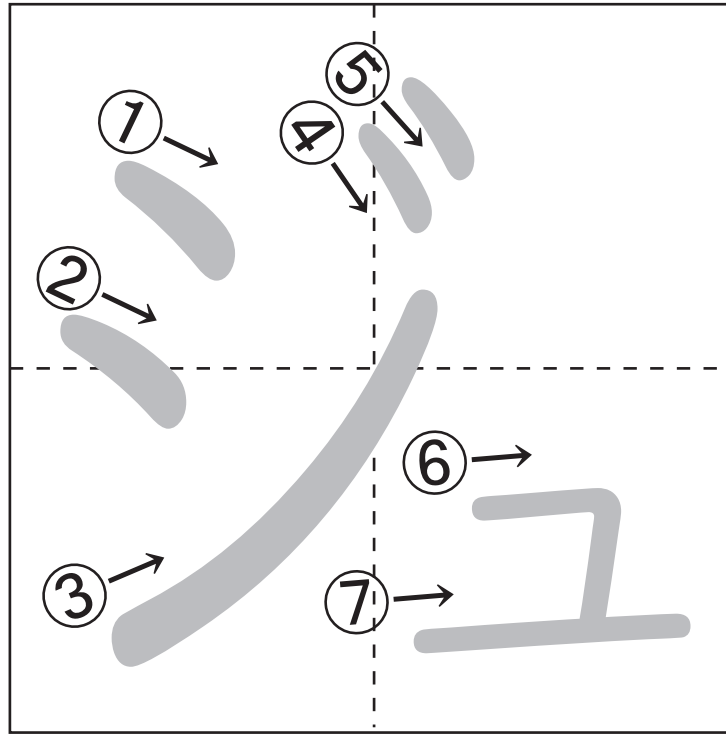
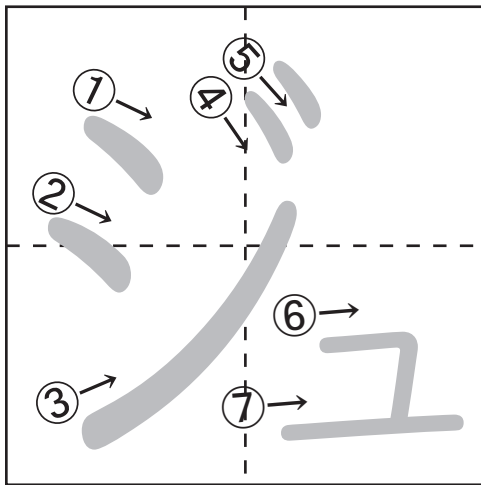
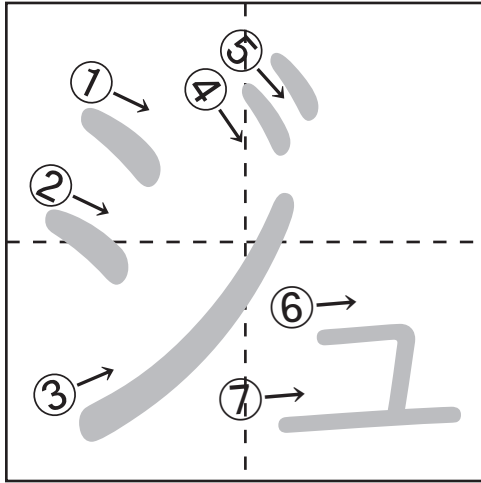
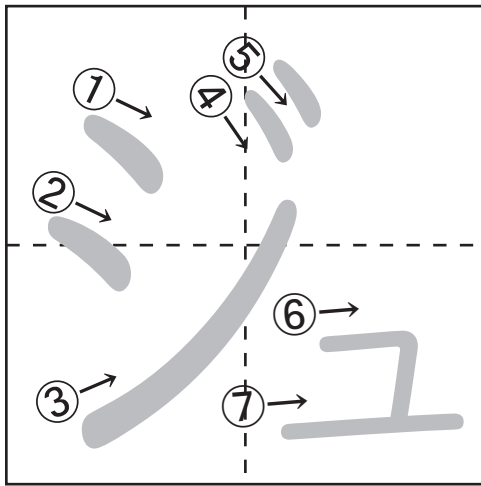
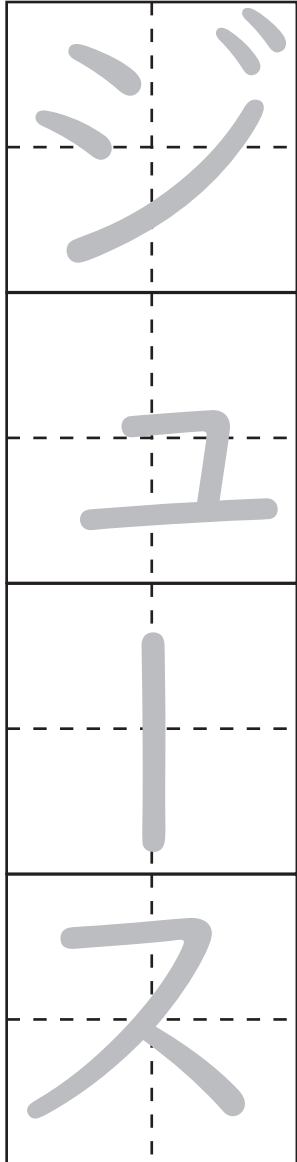

かきかた 7かく

①②③④⑤⑥⑦の
じゅんばんでかきましょう

ひらがなの
れんしゅう
を
しよ。。

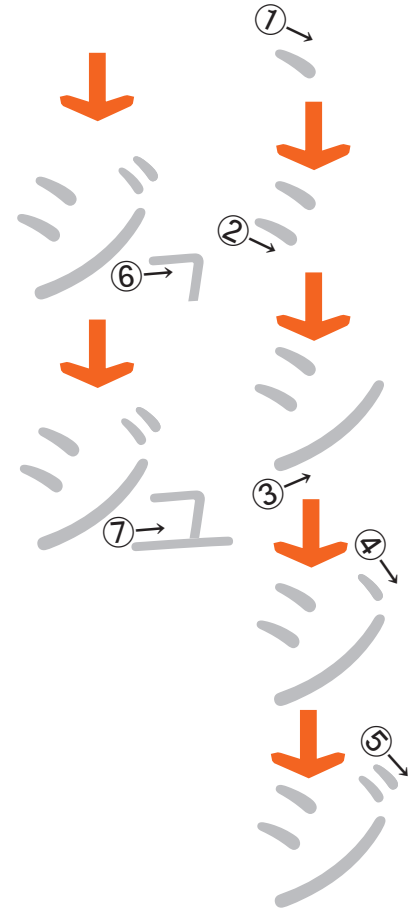

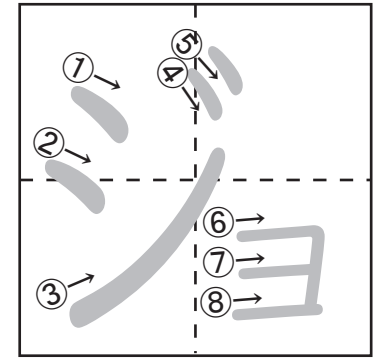
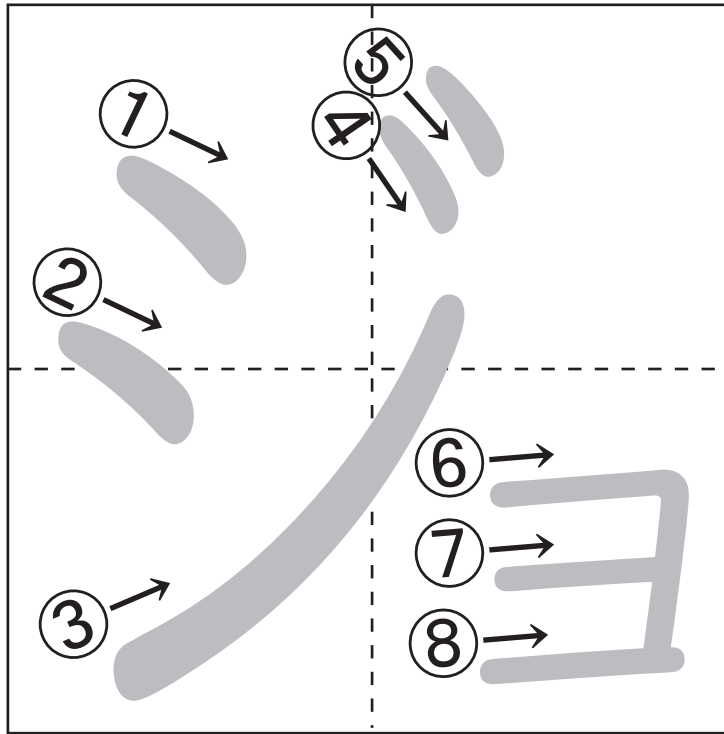
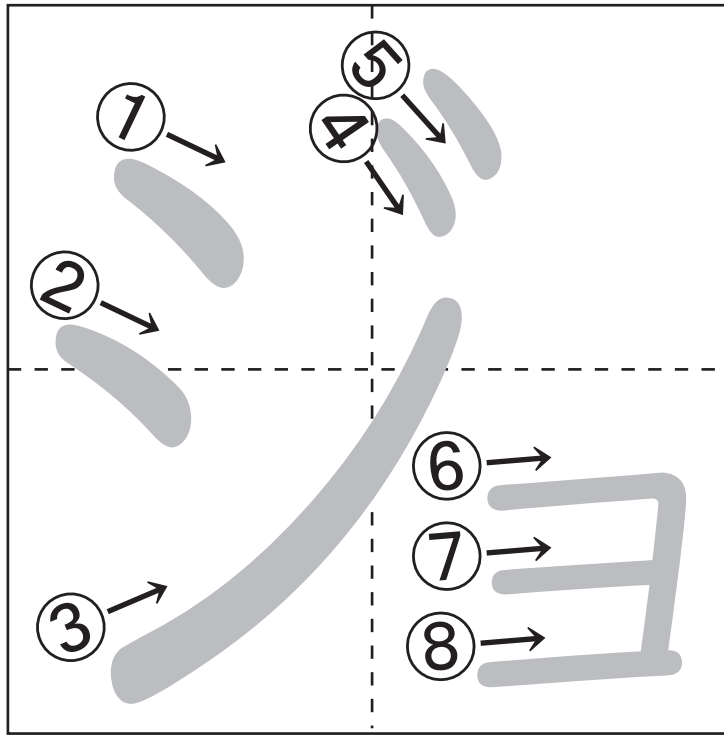
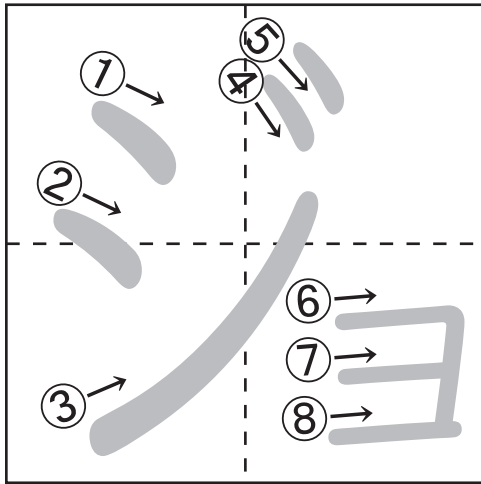
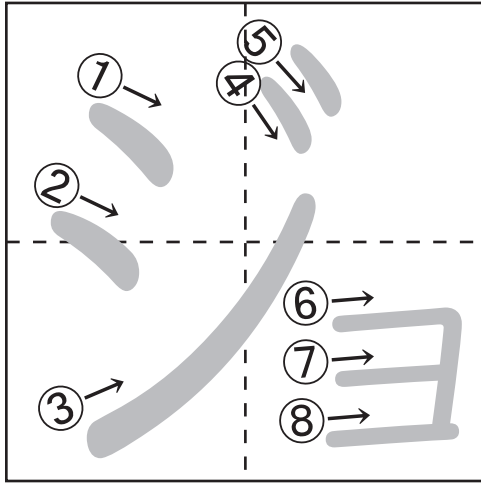
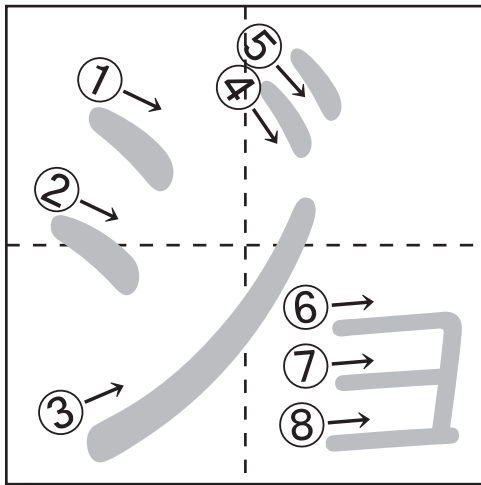
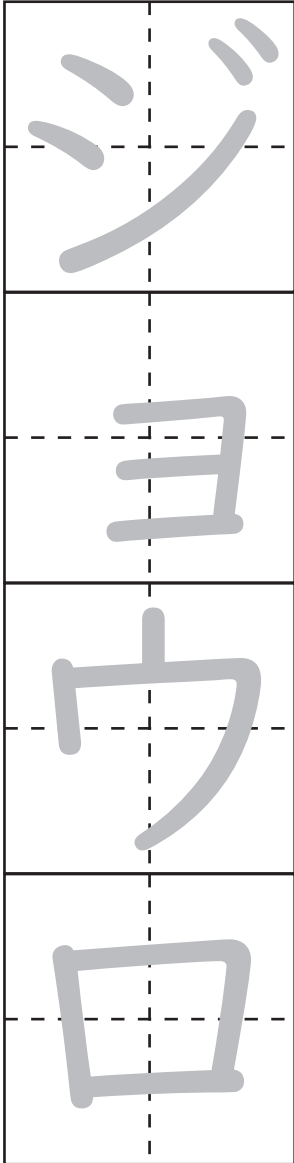
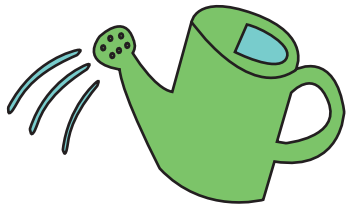

かきかた 8かく

①②③④⑤⑥⑦⑧の
じゅんばんでかきましょう

ひらがな
の
れんしゅう
を
しよび。

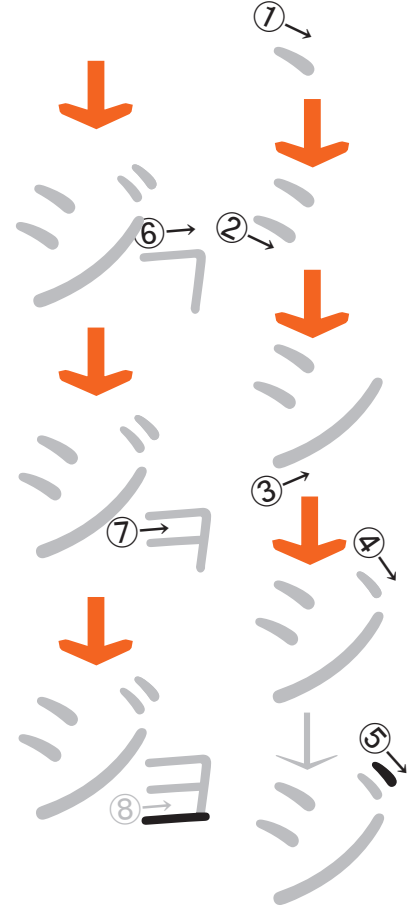

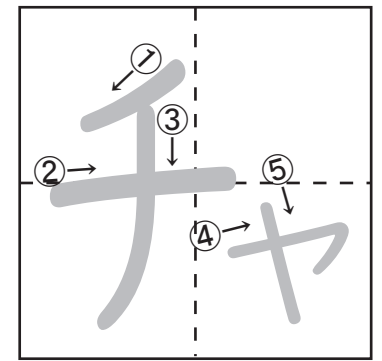
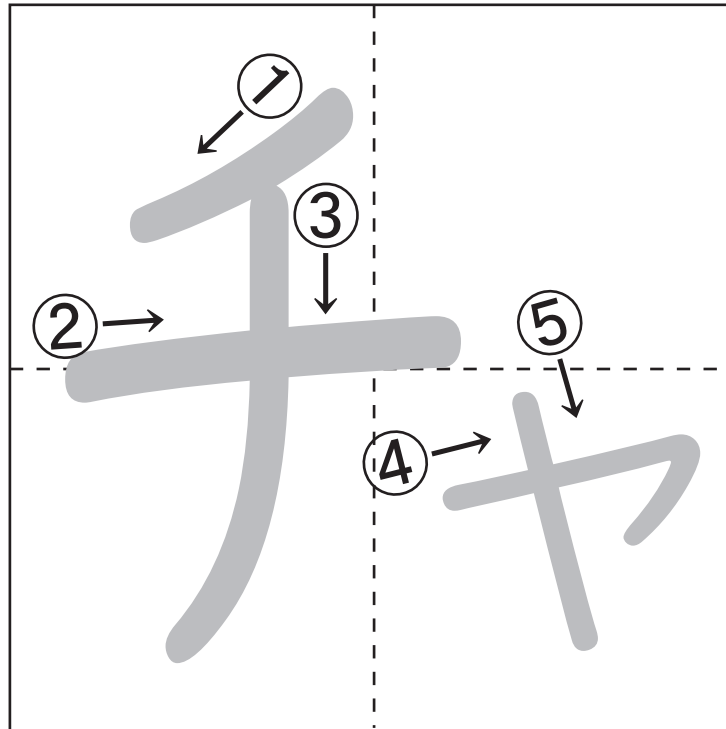
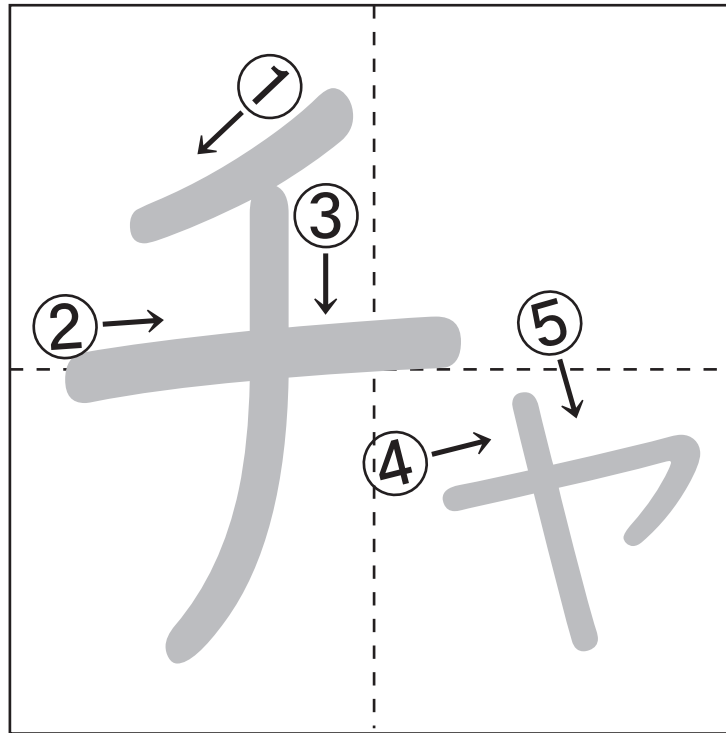
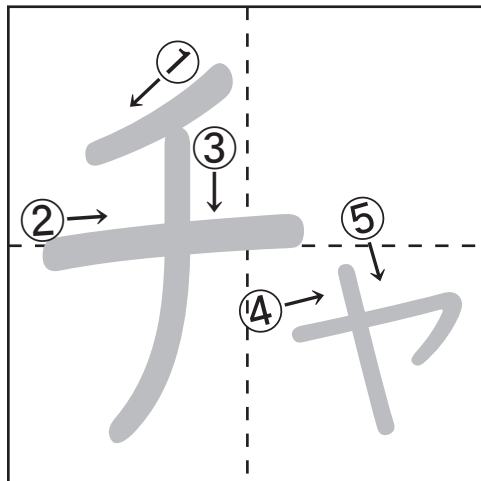
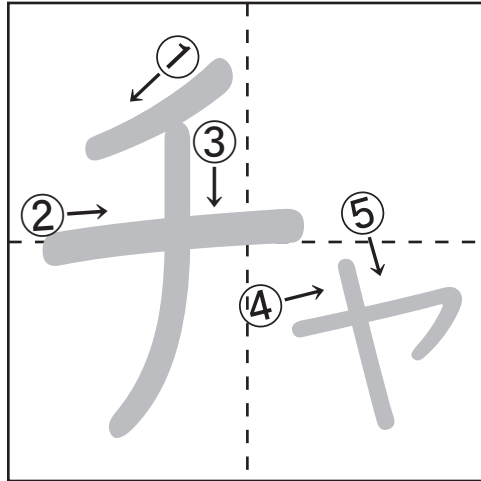
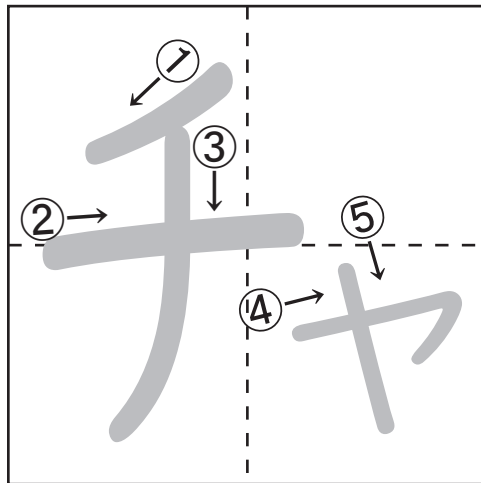
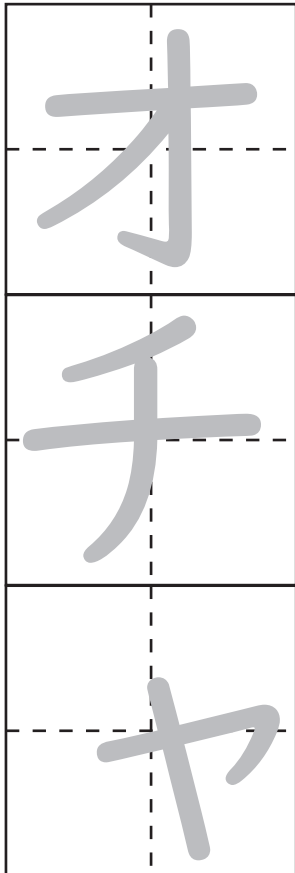
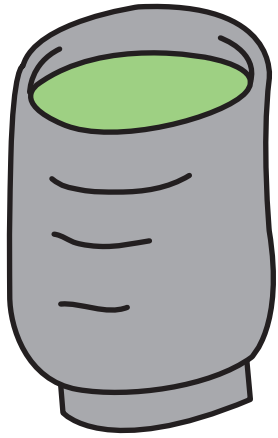

かきかた 5かく

①②③④⑤のじゅんばんで
かきましょう

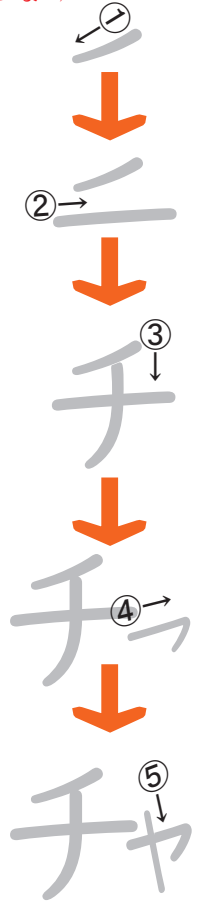

ひらがなの
れんしゅうを
しよび。

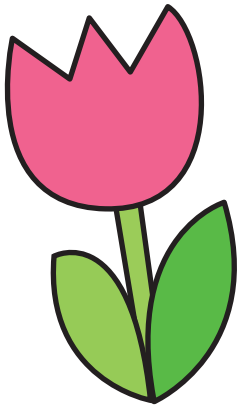

	チ
リ	ユ
ッ	ー
プ	

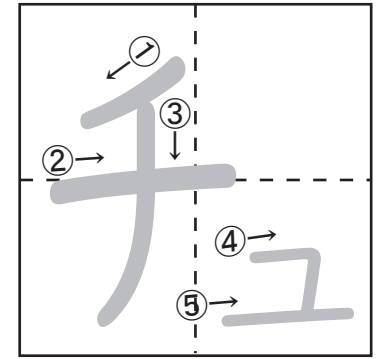
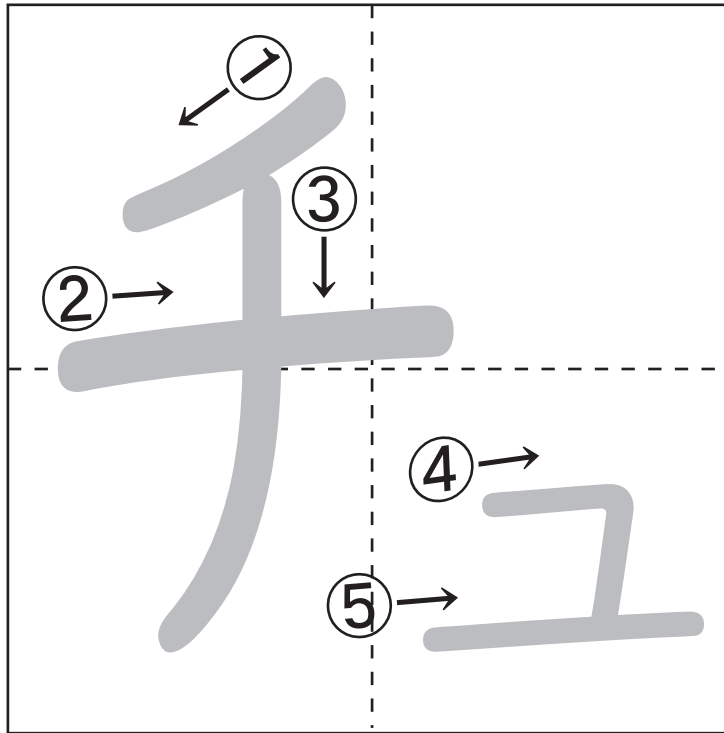
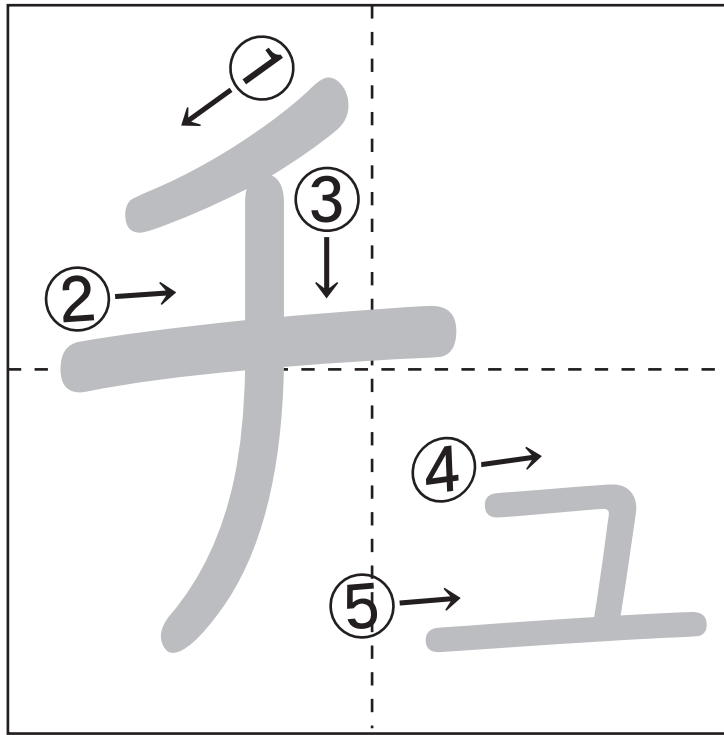
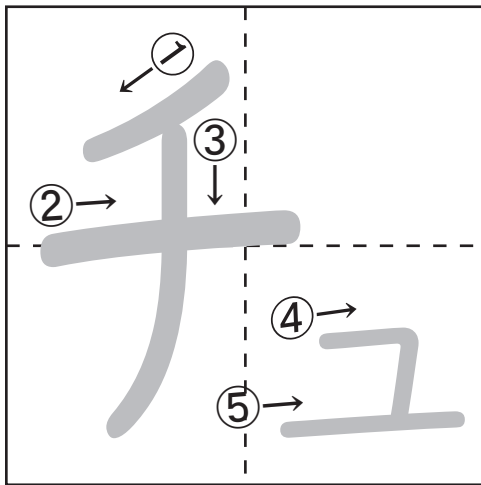
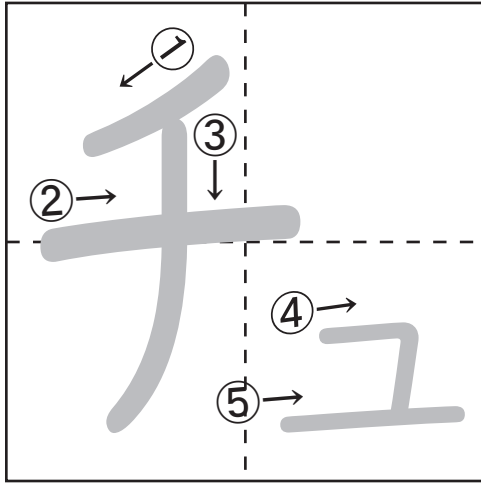
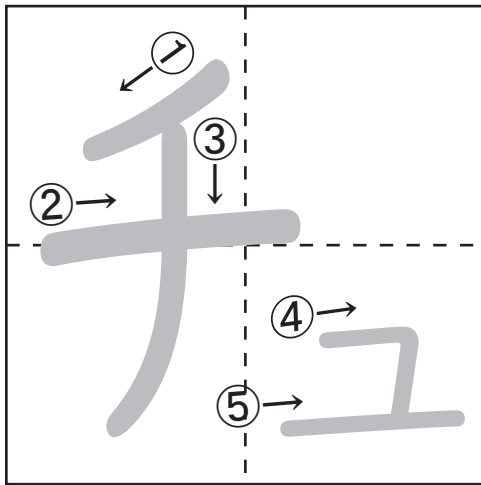

かきかた 5かく

①②③④⑤のじゅんばんで
かきましょう

ひらがなの
れんしゅうを
しよう。

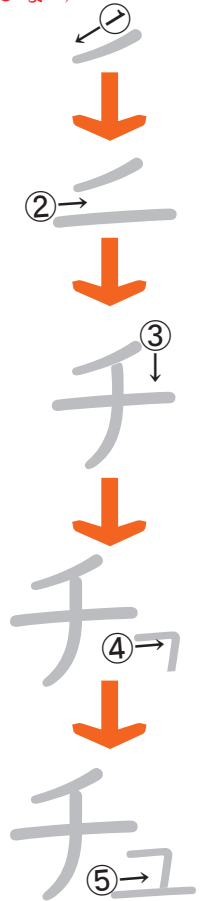

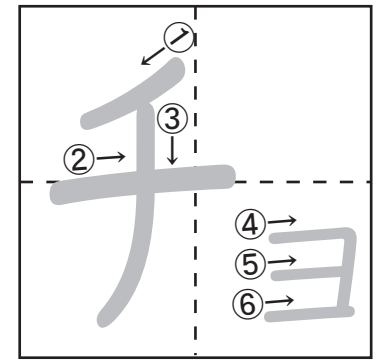
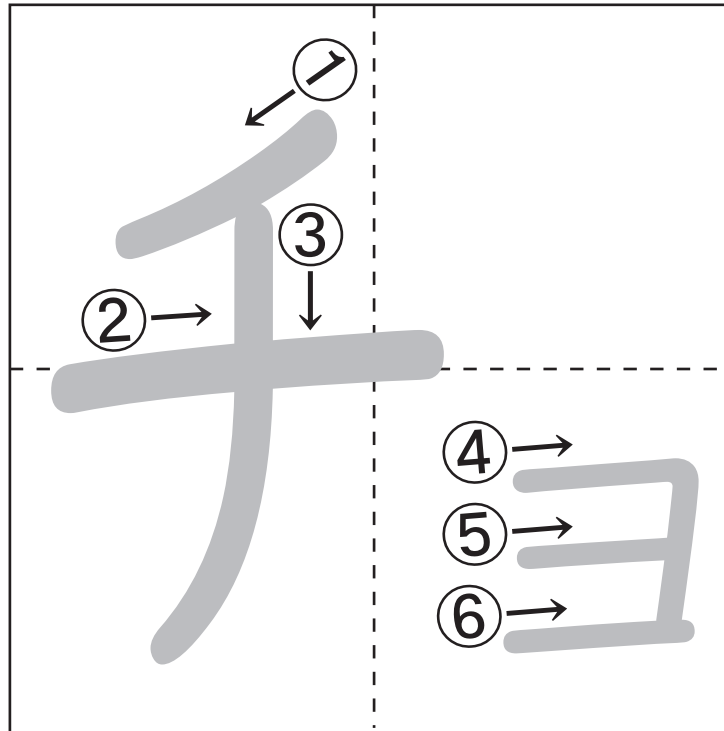
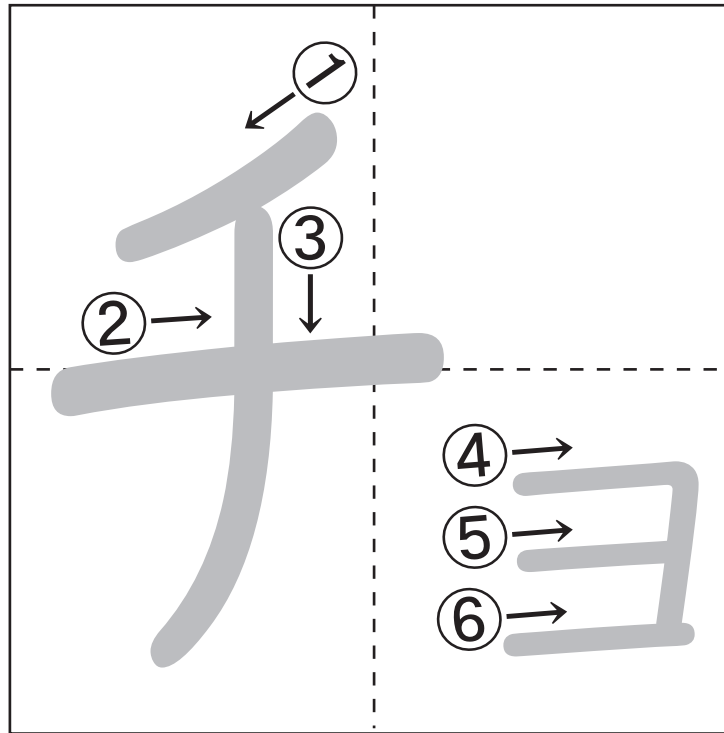
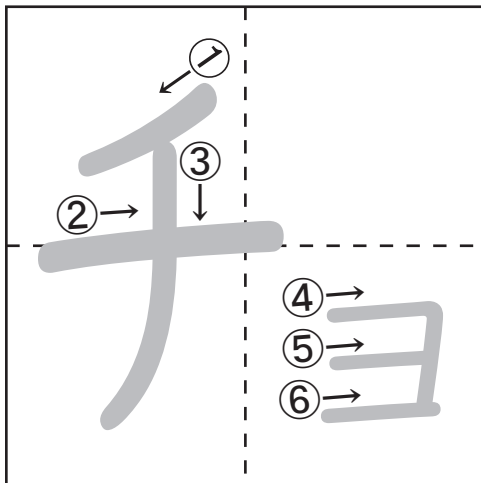
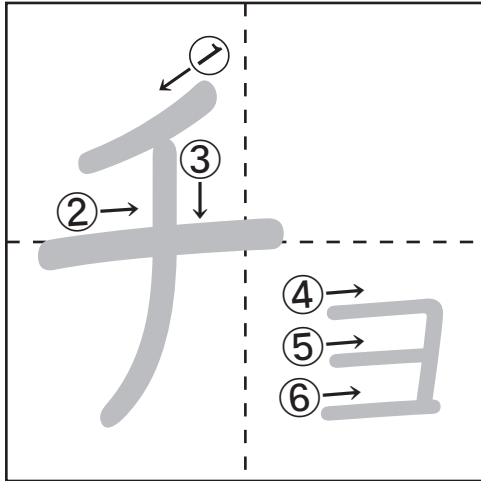
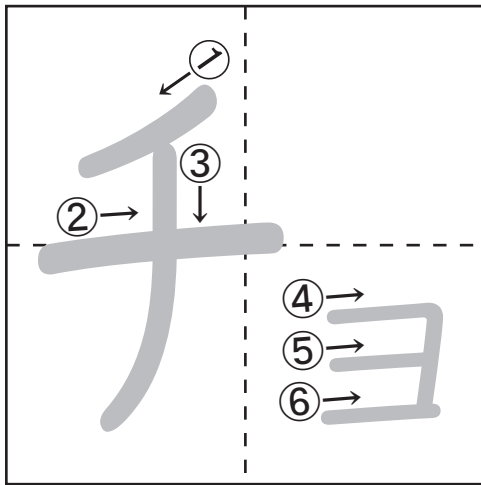
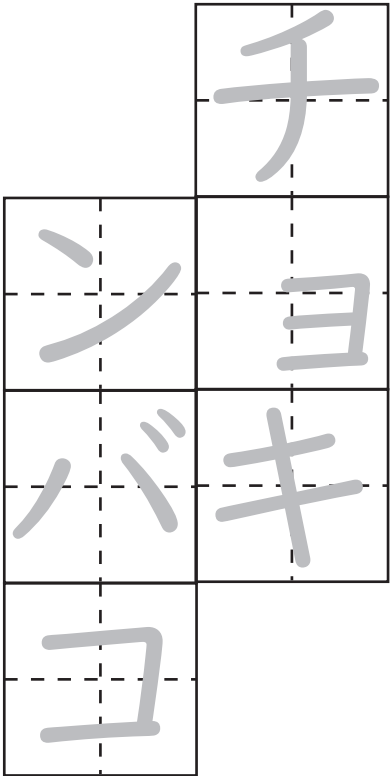
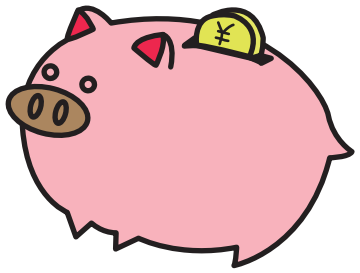

かきかた 6かく
①②③④⑤⑥のじゅんばん
でかきましょう

ひらがなの
れんしゅうを
しよび。

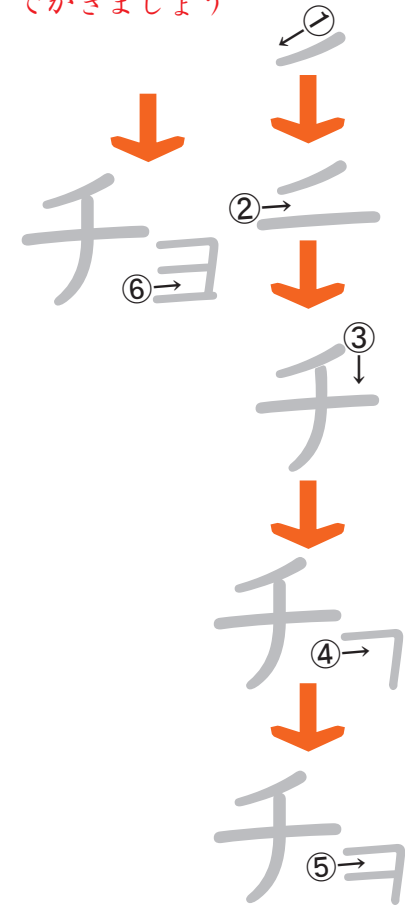

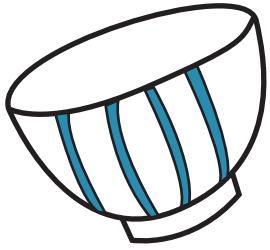

チ
ヤ
ワ
ン

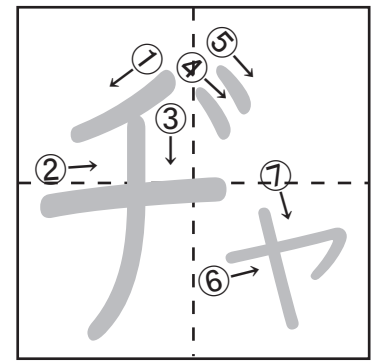
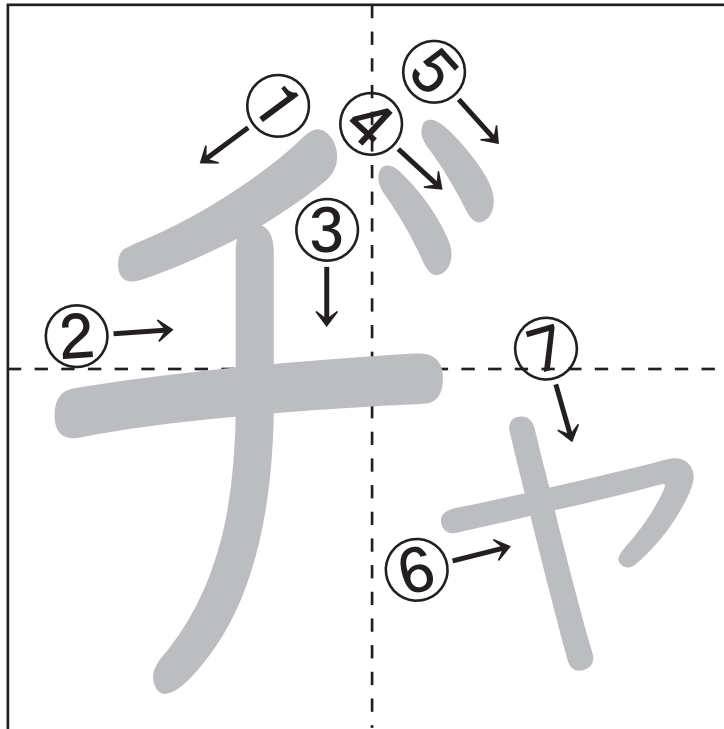
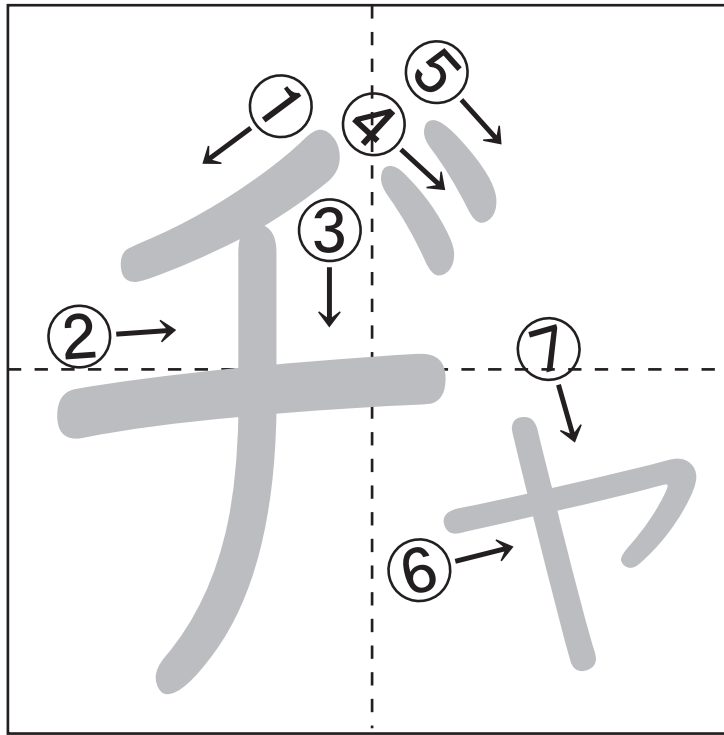
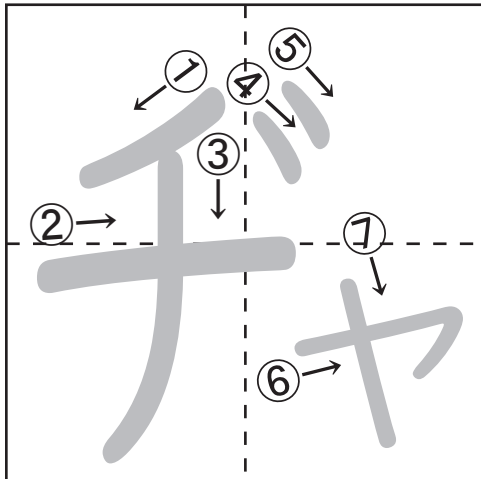
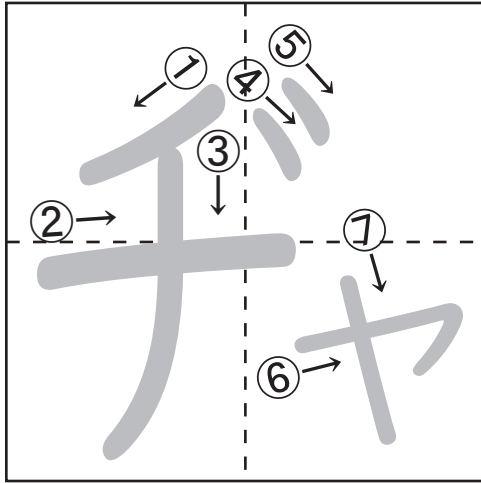
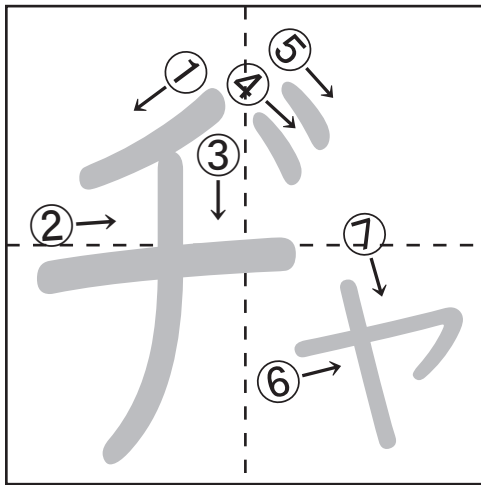

かきかた 7かく

①②③④⑤⑥⑦の
じゅんばんでかきましょう

ひらがな

の

れんしゅう

を

しゅりょう。

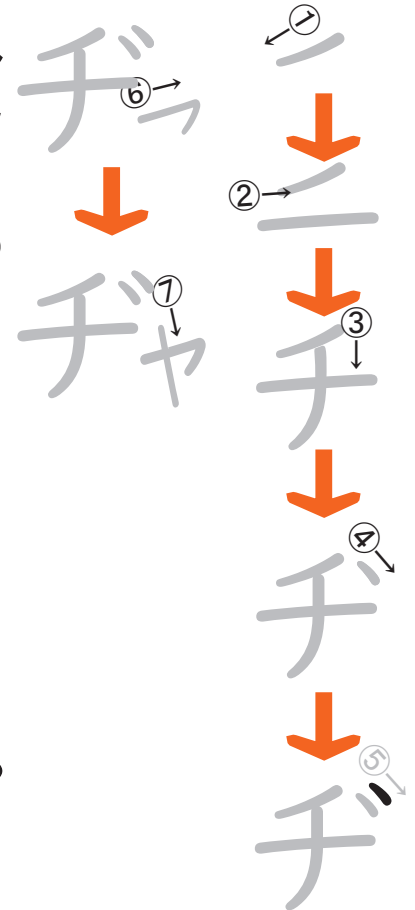



セ	カ
チ	イ
ユ	
ウ	

かきかた 7かく
①②③④⑤⑥⑦の
じゅんばんでかきましょう

ひらがなの
れんしゅうを
しよび。

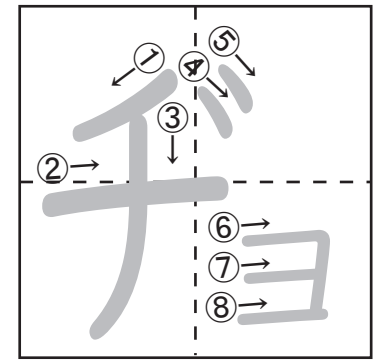
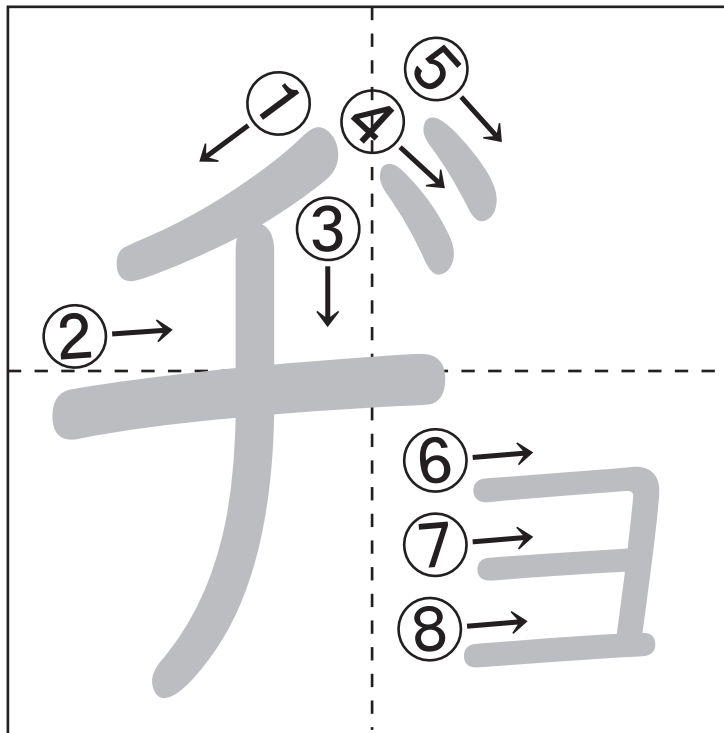
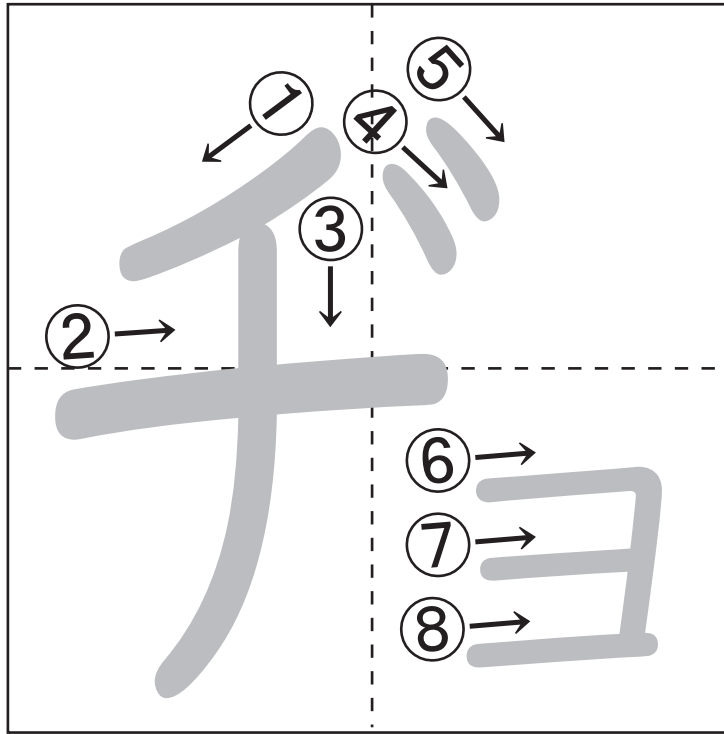
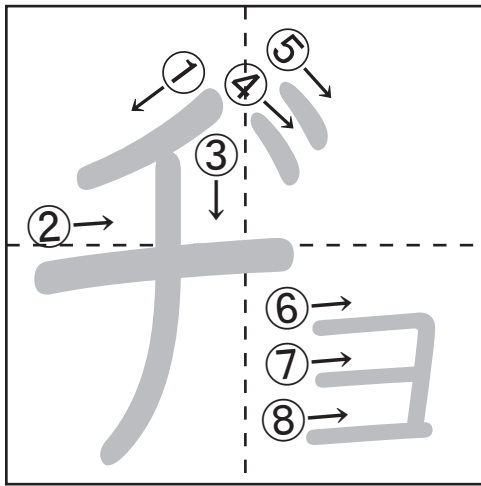
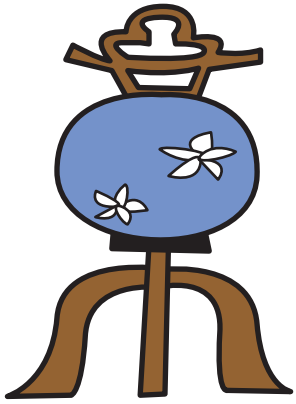

かきかた 8かく
 ①②③④⑤⑥⑦⑧の
 じゅんばんでかきましょう

ひらがなの
 の
 れんしゅうを
 しよび。

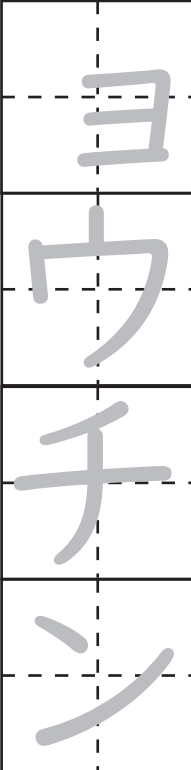
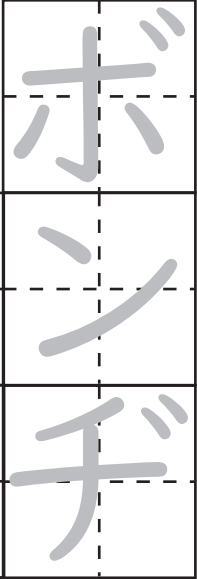
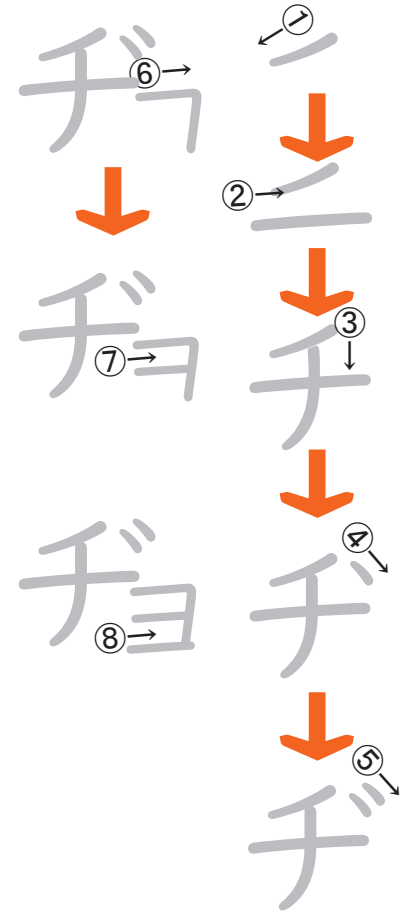

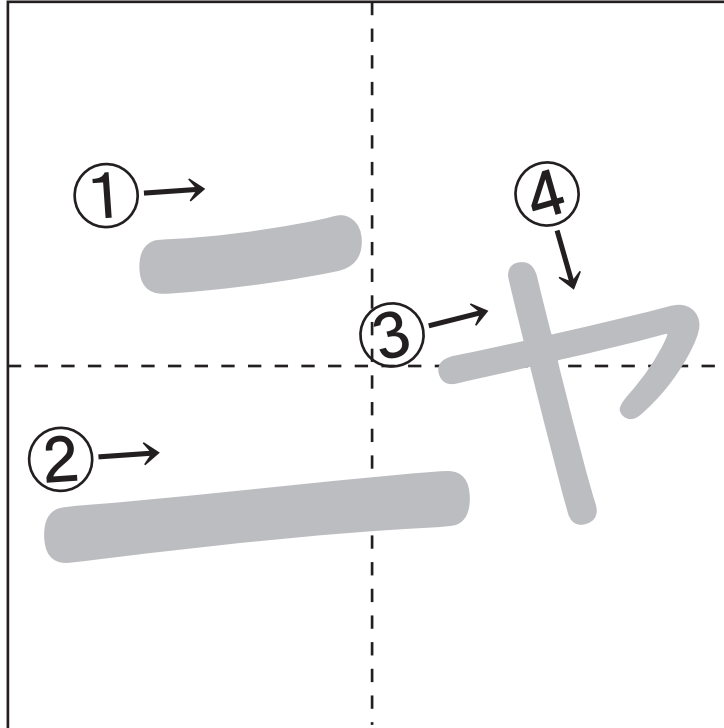
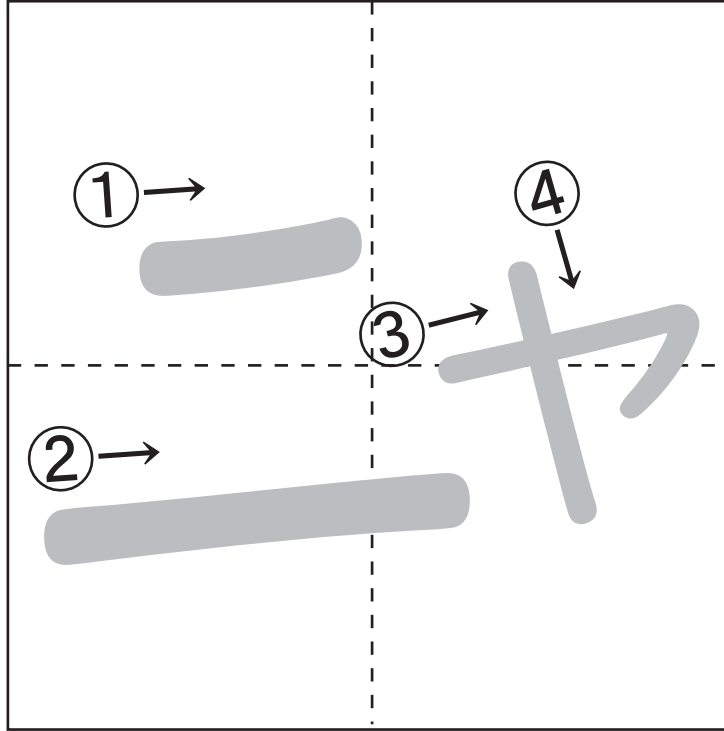
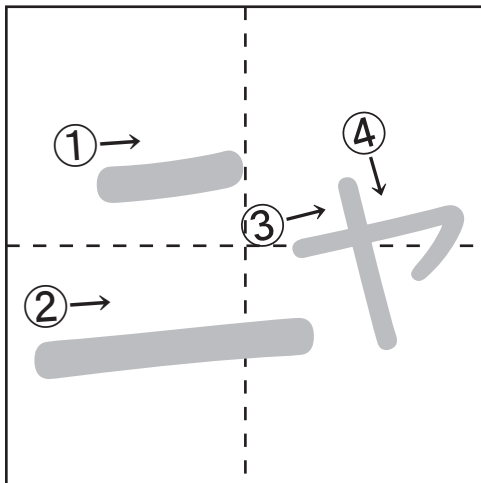
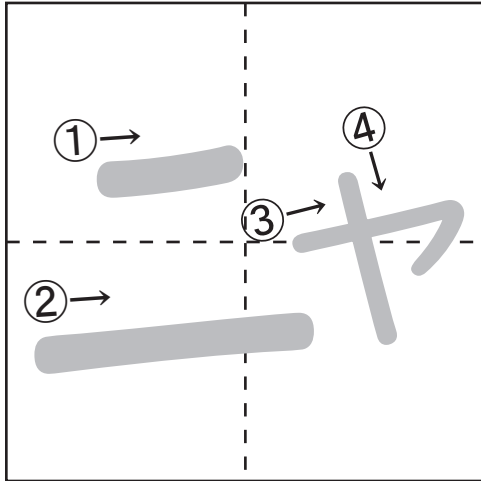
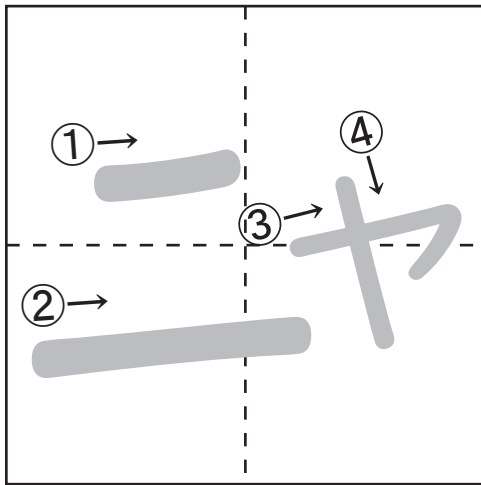
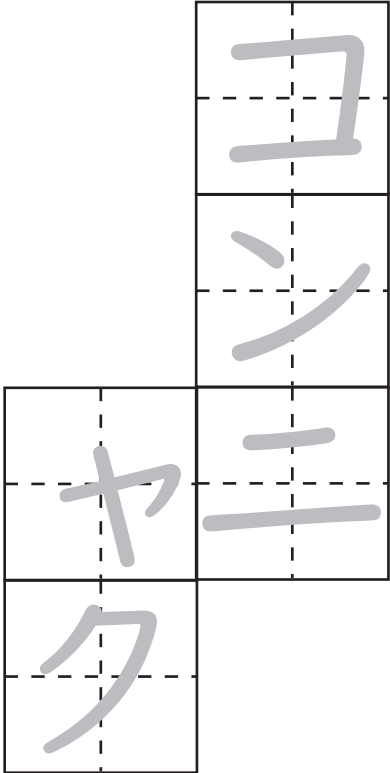
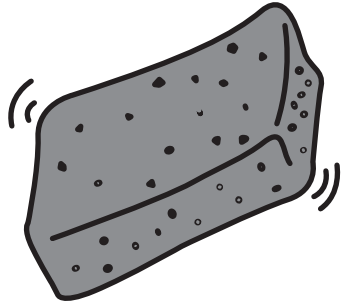

ひらがなの
れんしゅうを
しよぼう。

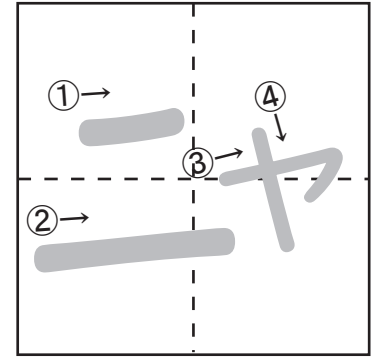

かきかた 4かく
①②③④のじゅんばんで
かきましょう

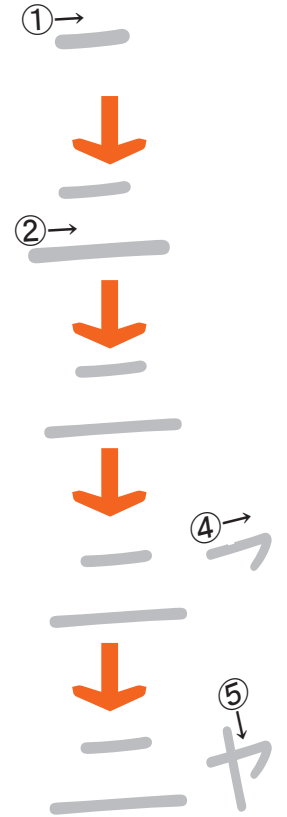

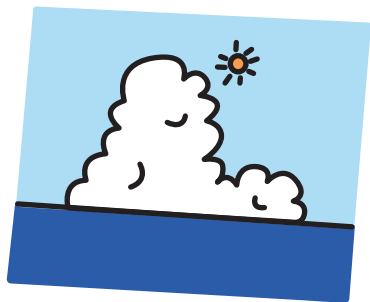

	ニ
ド	ユ
ウ	ウ
グ	
モ	

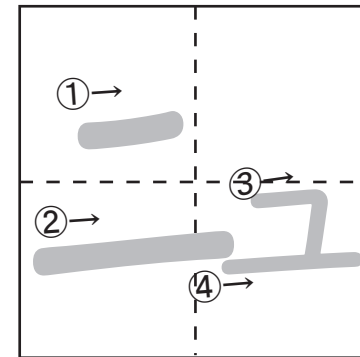
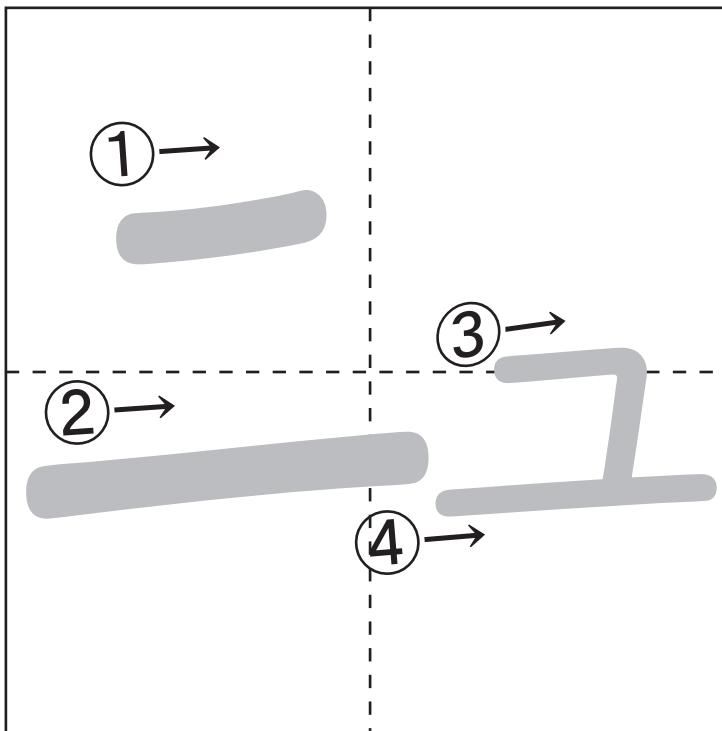
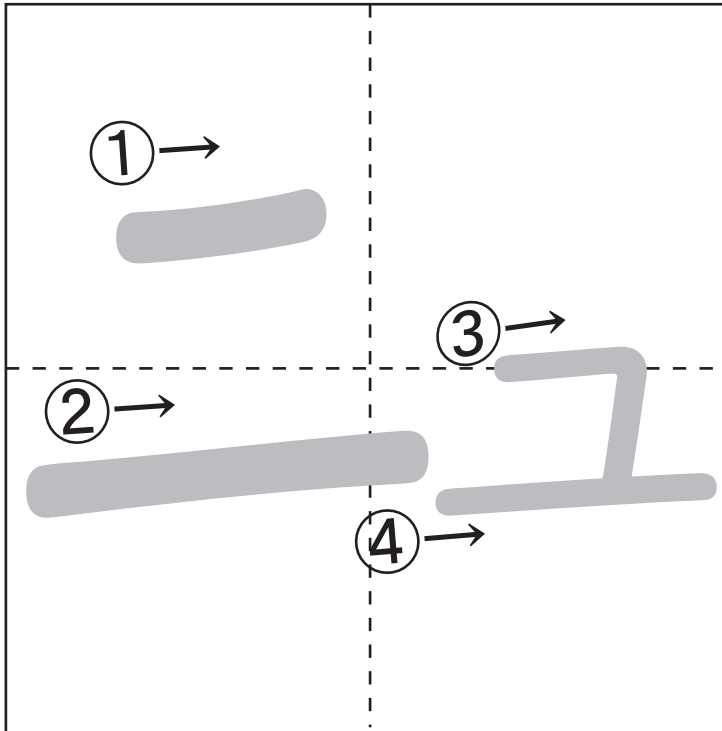
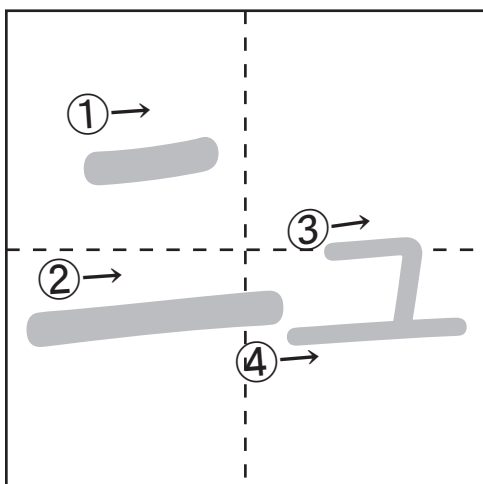
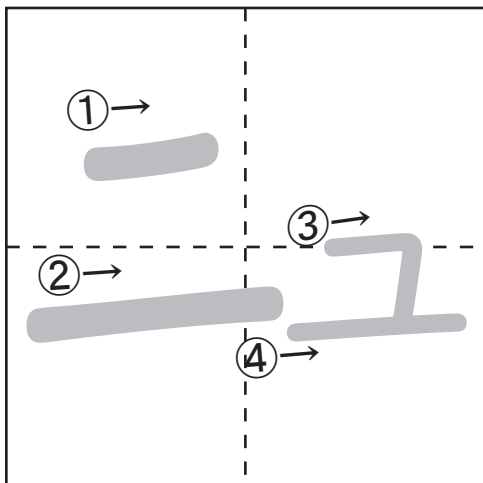
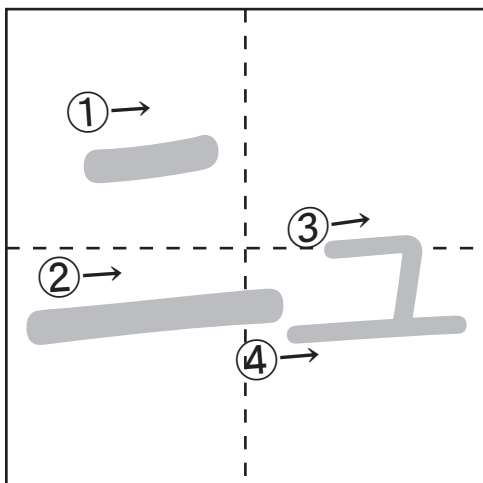

かきかた 4かく

①②③④のじゅんばんで
かきましょう

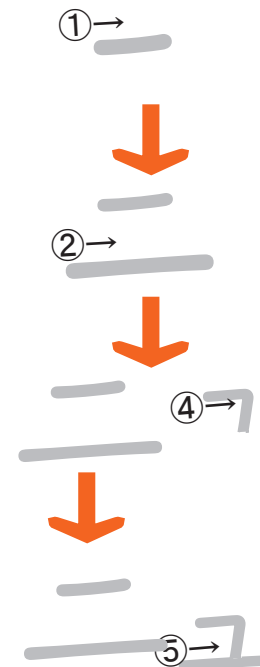

ひらがなの
れんしゅう
をしゅう。

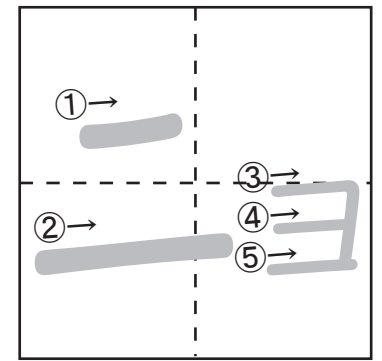
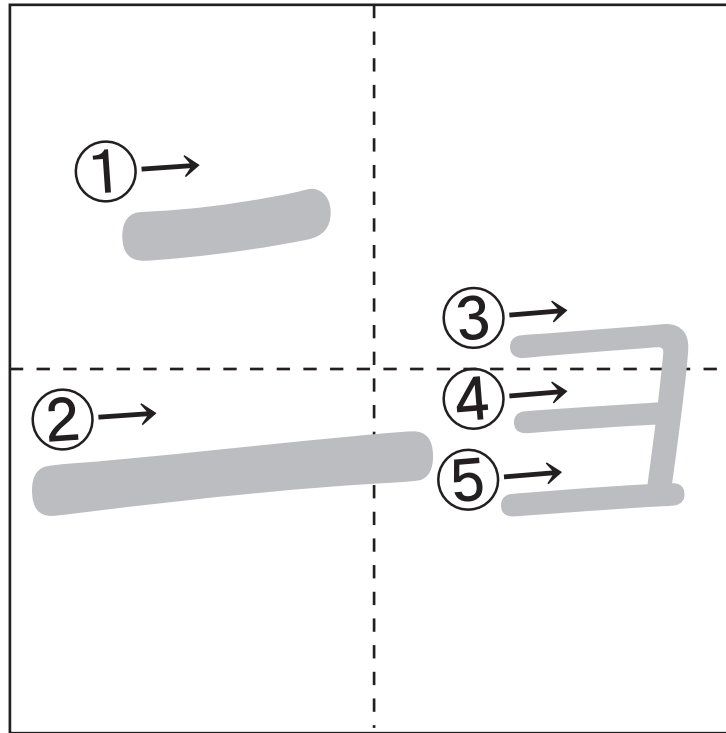
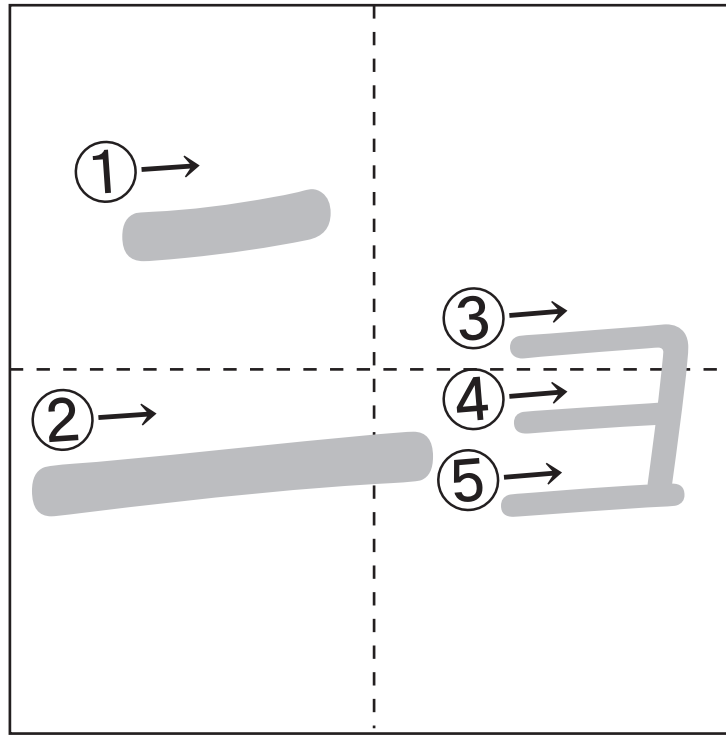
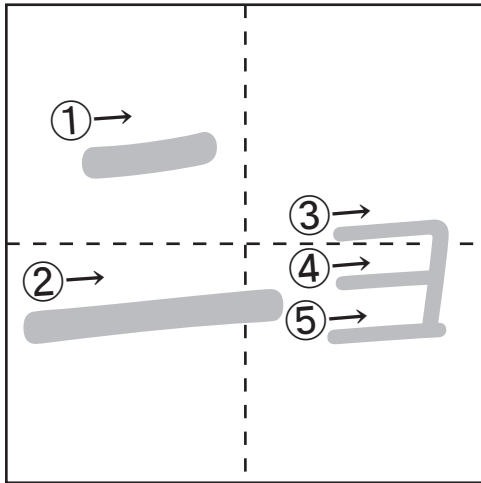
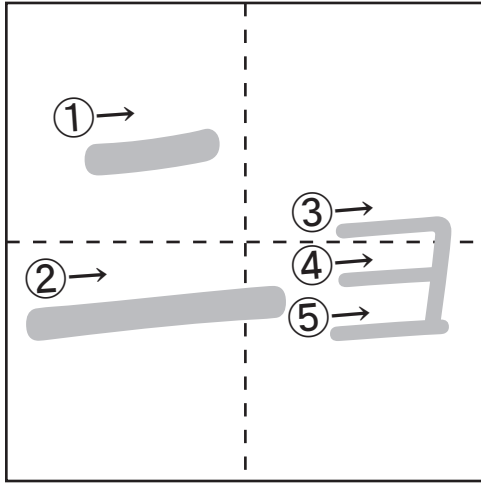
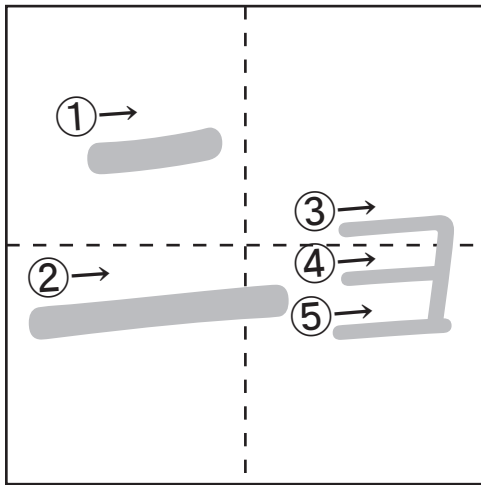
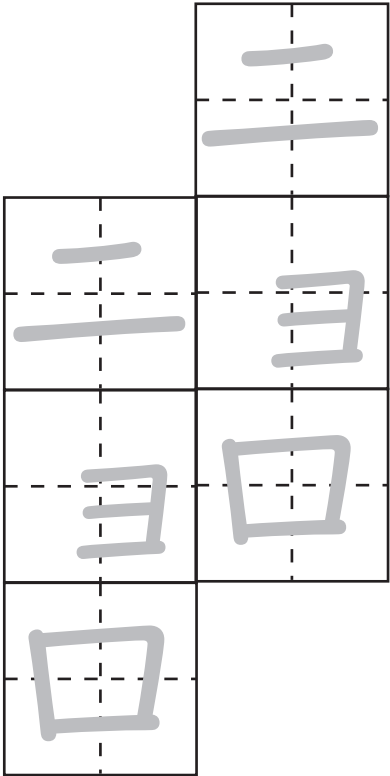
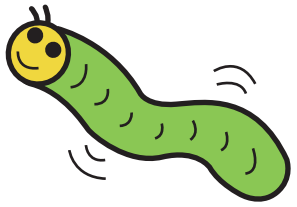

かきかた 5かく
①②③④⑤のじゅんばん
でかきましょう

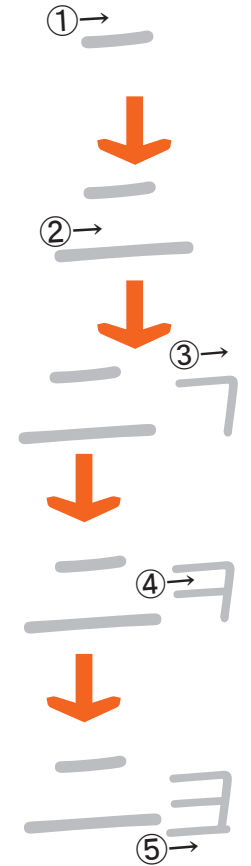

ひらがな
の
れんしゅう
を
しゅう。

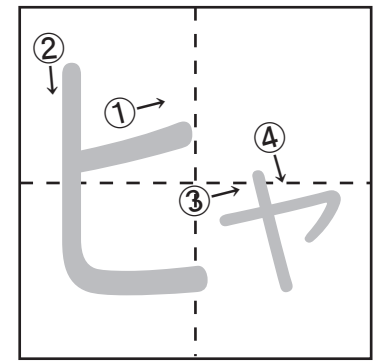
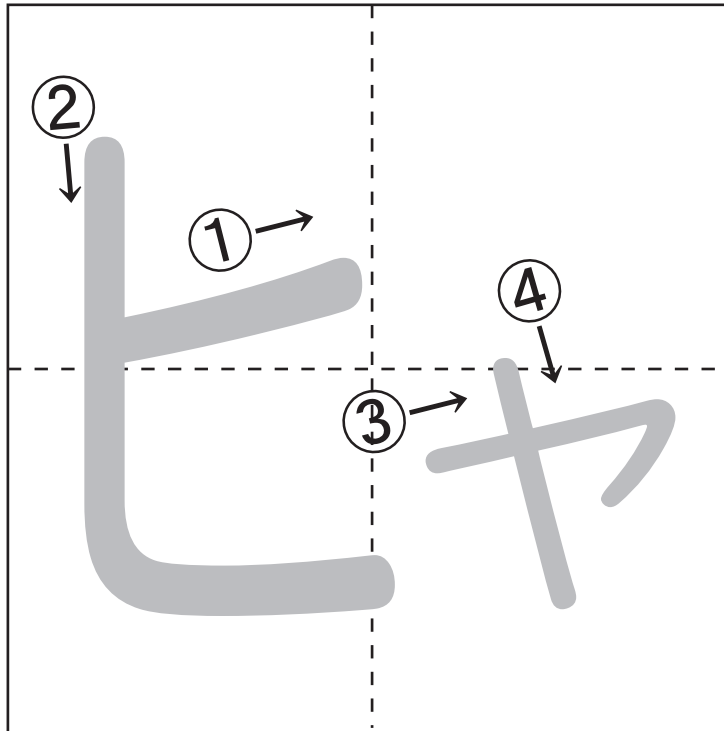
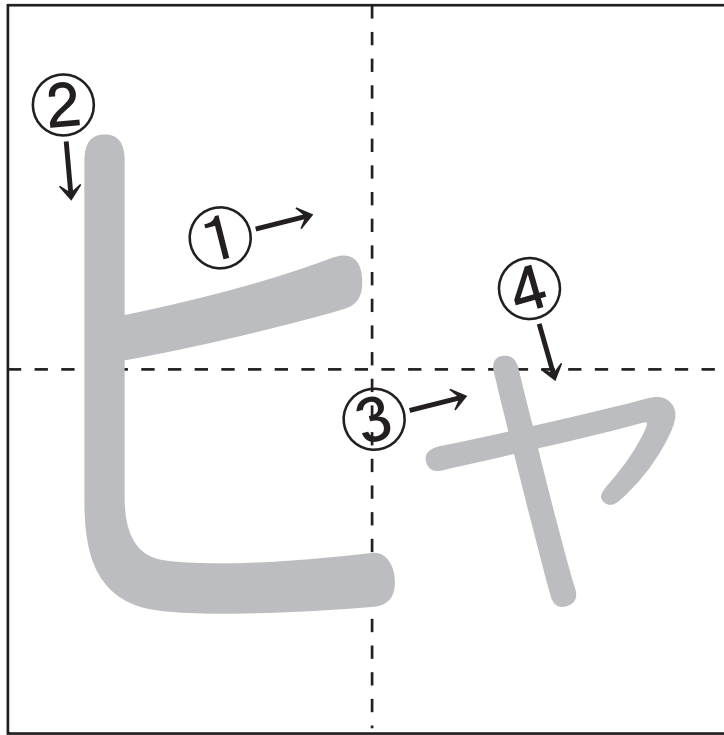
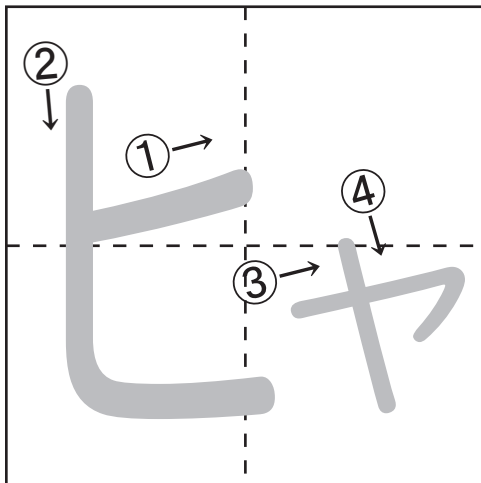
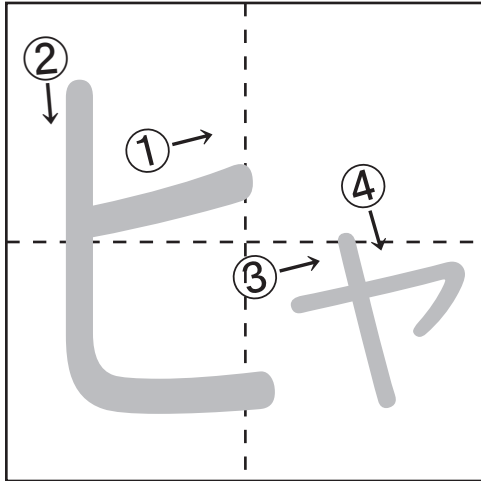
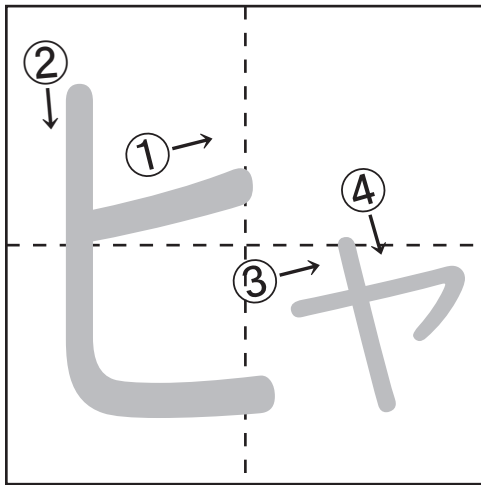
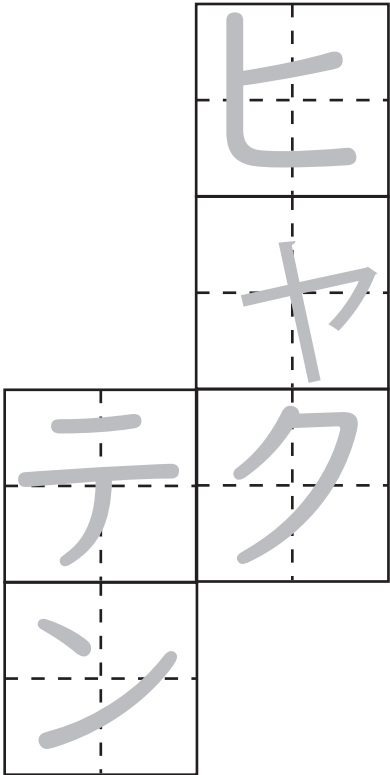
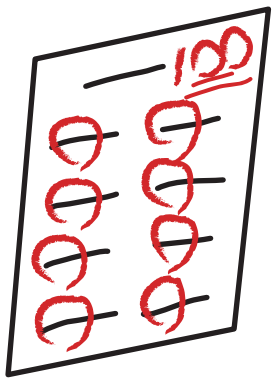

かきかた 4かく
①②③④のじゅんばんで
かきましょう

ひらがなの
れんしゅうを
しよ。。

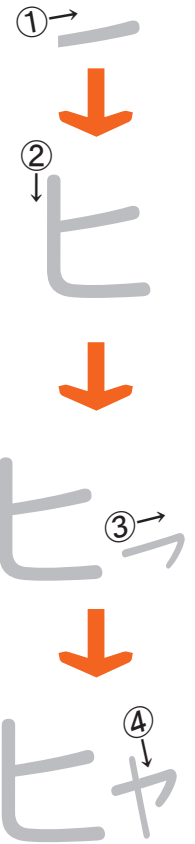

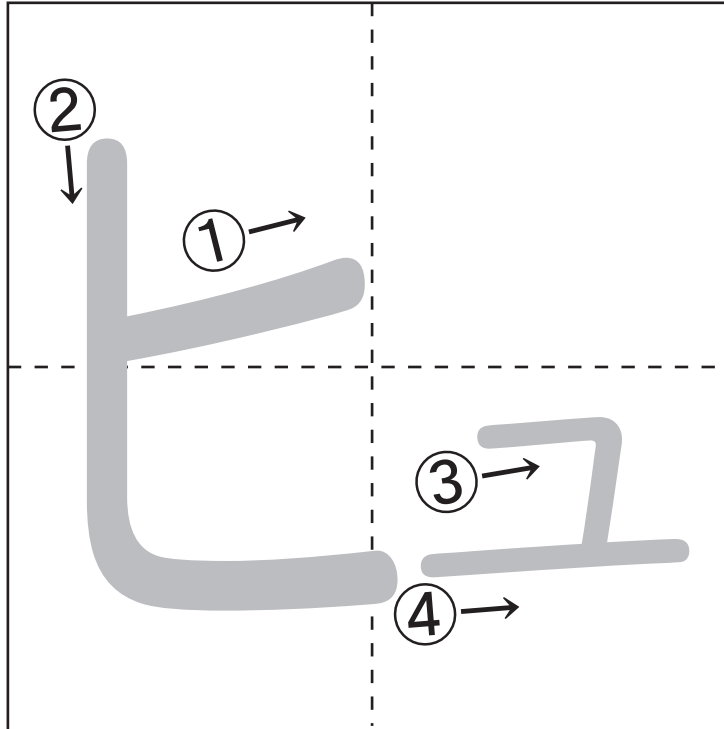
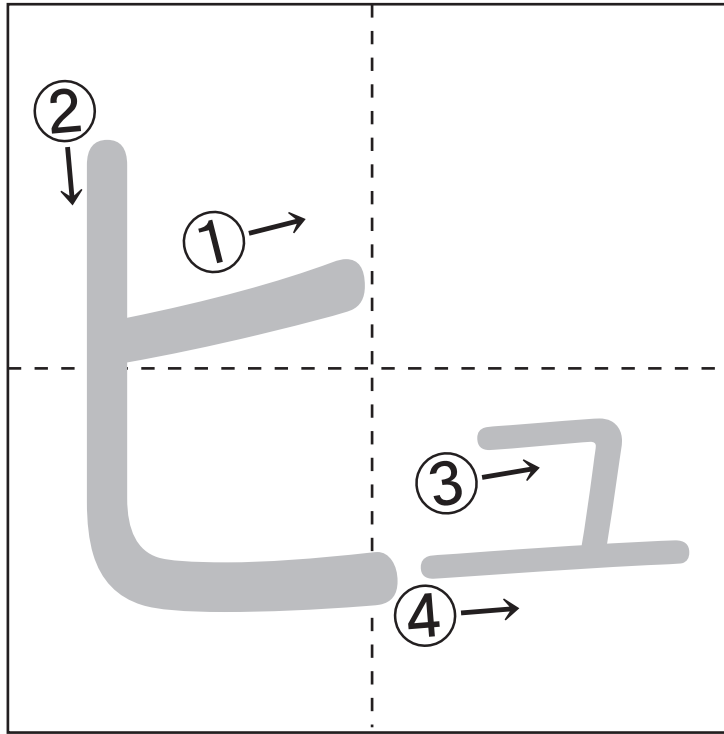
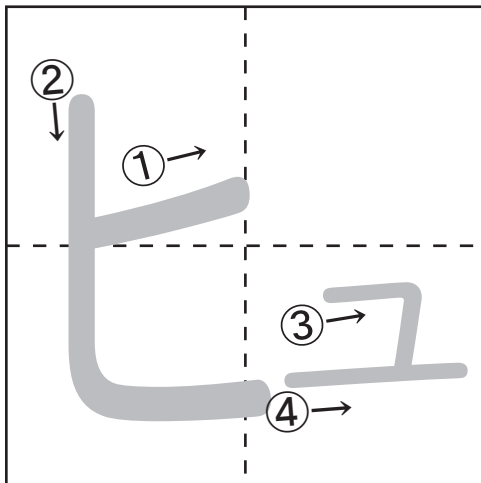
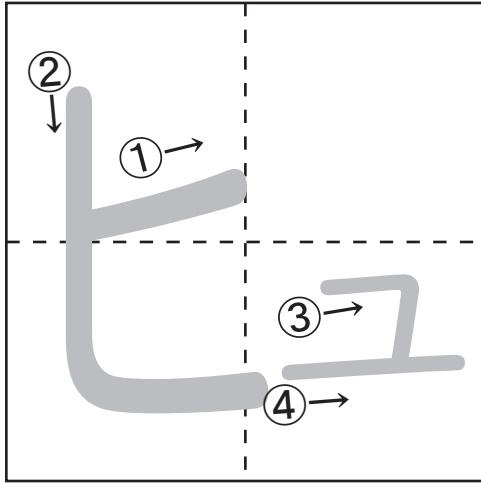
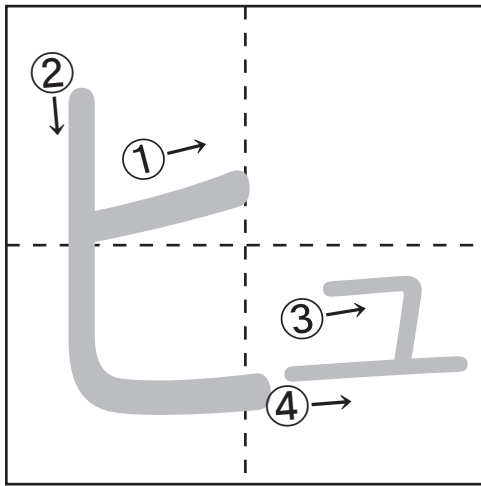
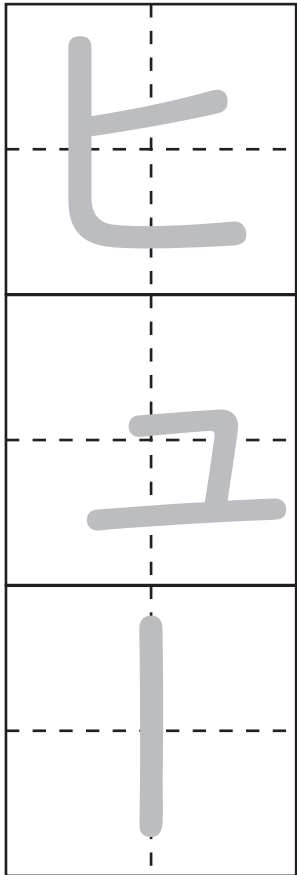
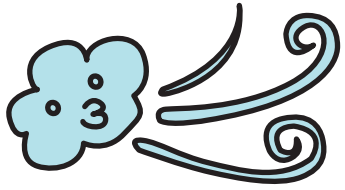

ひらがなの
れんしゅうを
しよう。

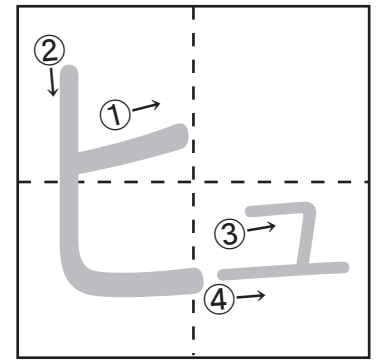

かきかた 4かく
①②③④のじゅんばんで
かきましょう



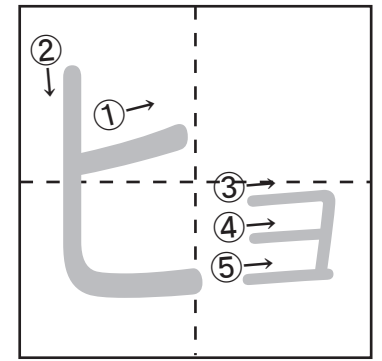
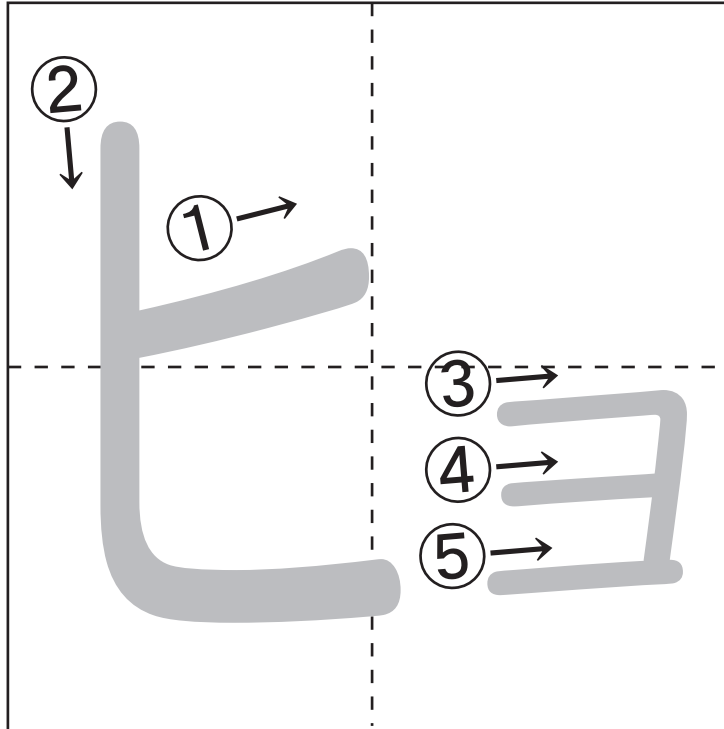
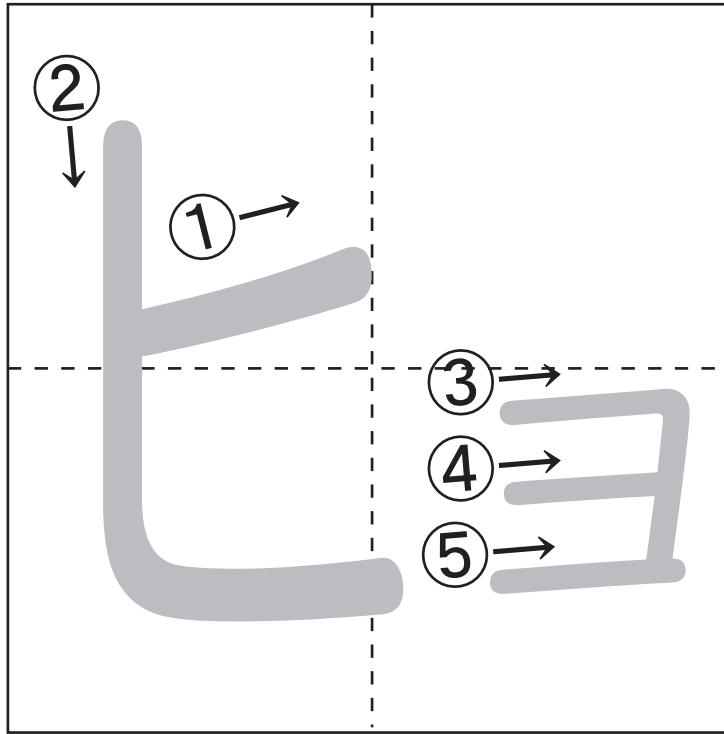
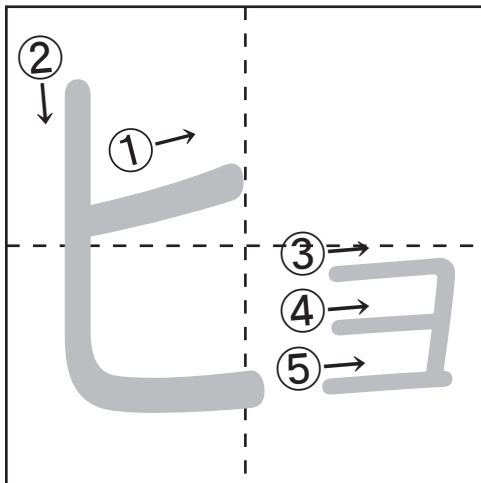
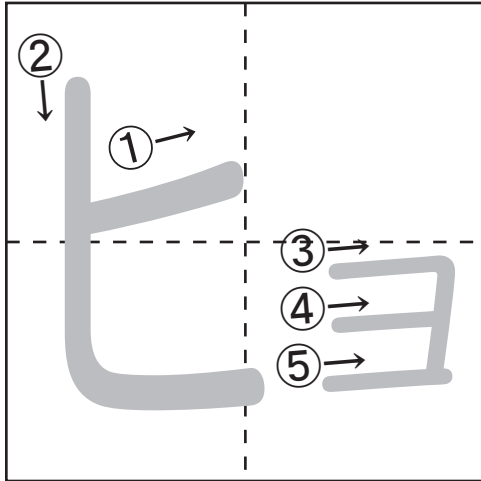
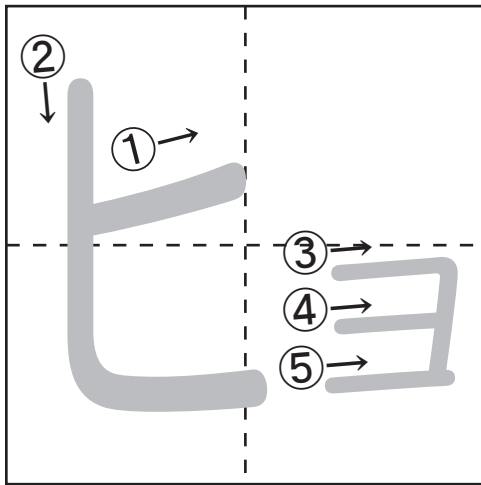
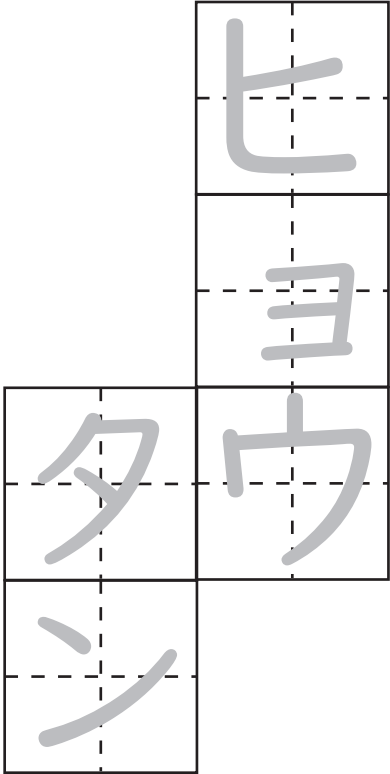

かきかた 5かく

①②③④⑤のじゅんばんで
かきましょう

ひらがな
の
れんしゅう
を
しよび。

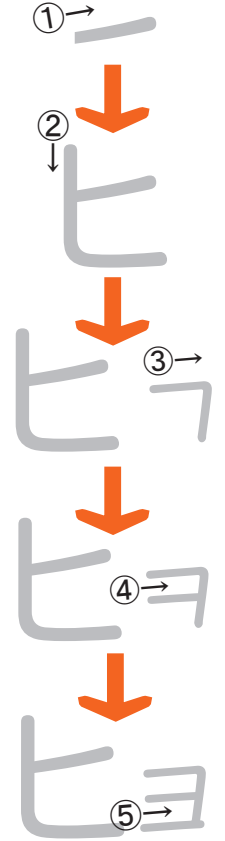

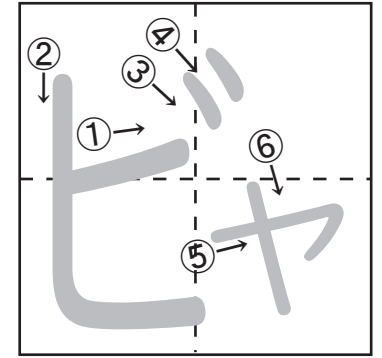
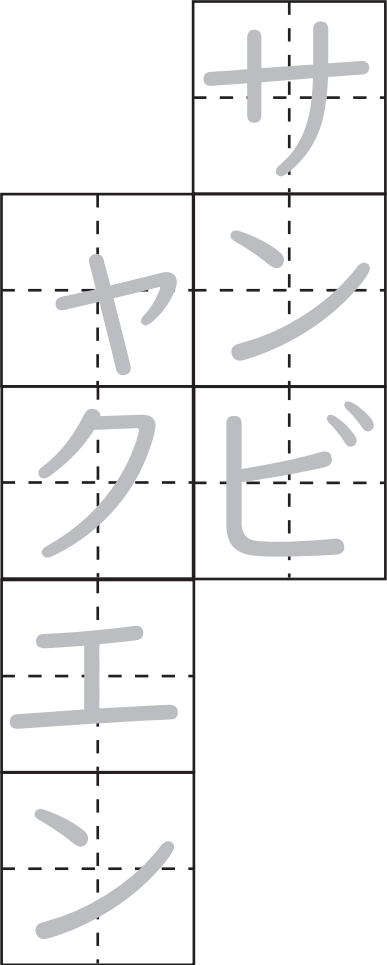
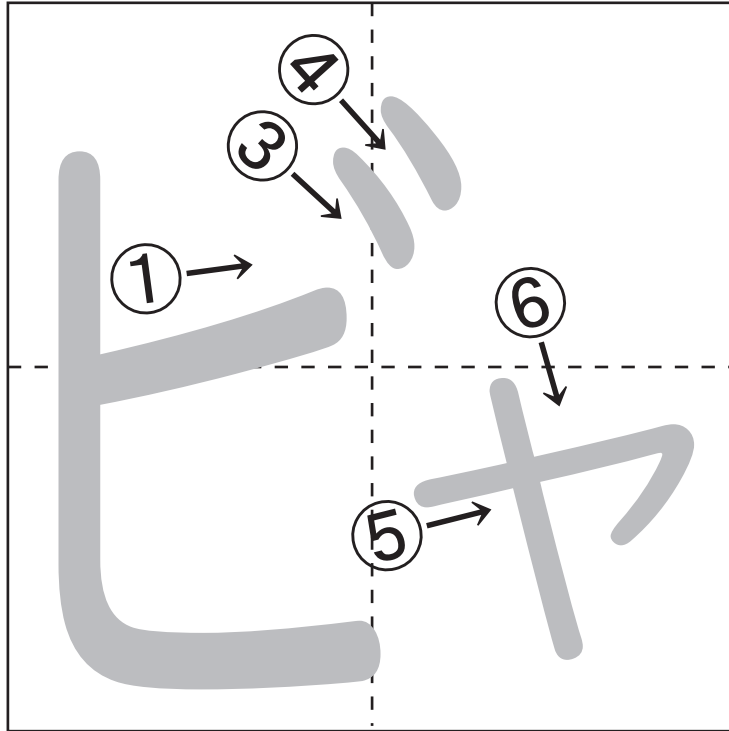
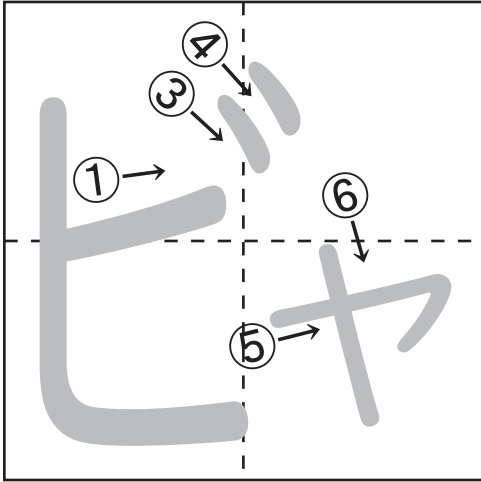
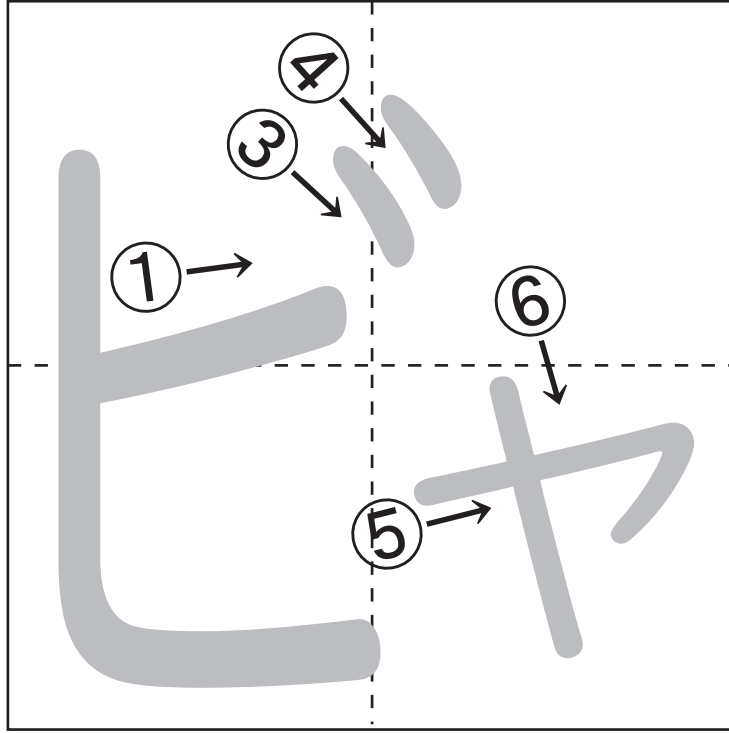
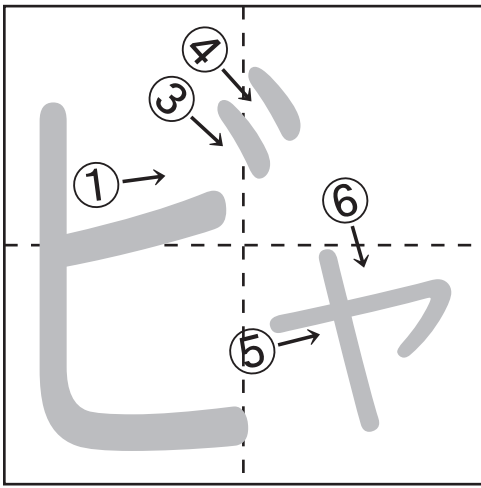

ひらがな

の

れんしゅう

を

しゅりょう。

かきかた 6かく
①②③④⑤⑥のじゅんばん
でかきましょう

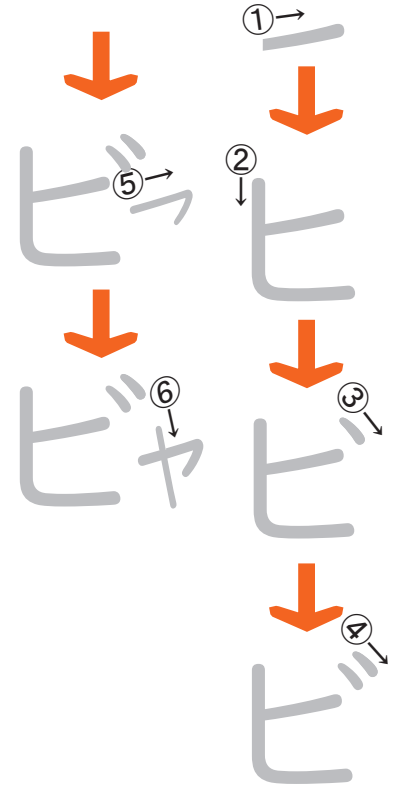

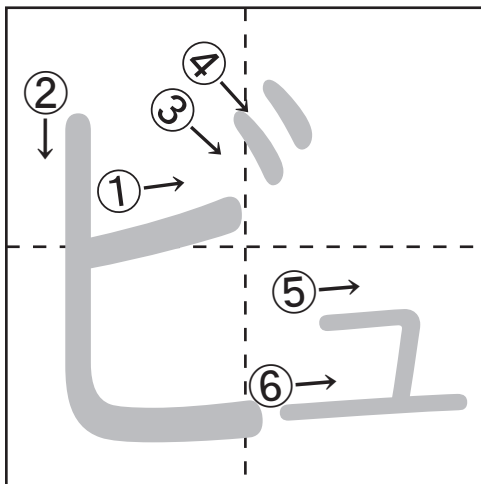
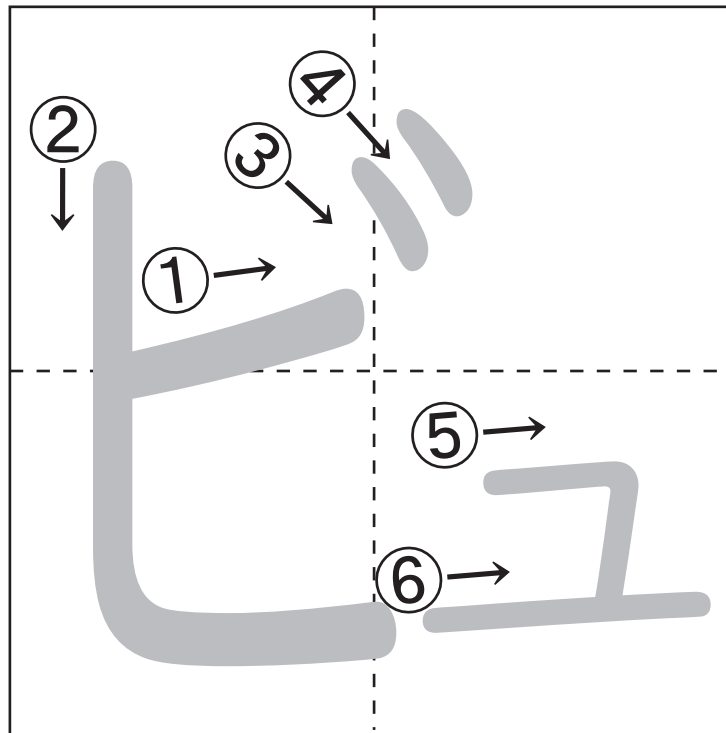
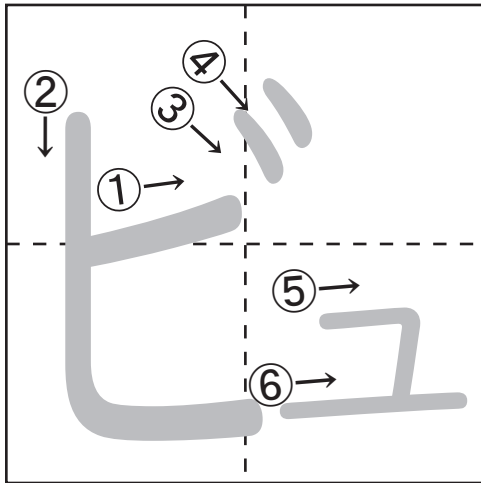
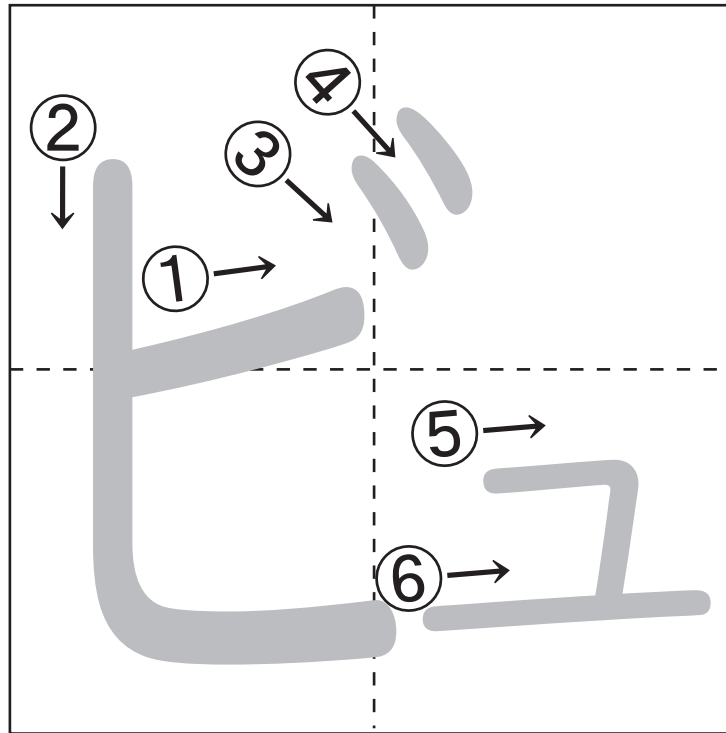
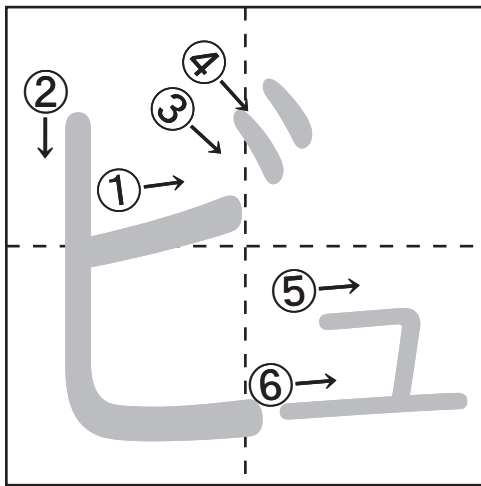
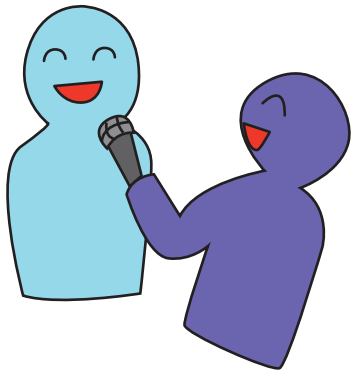

イ
ン
タ

び
ゅ
ー

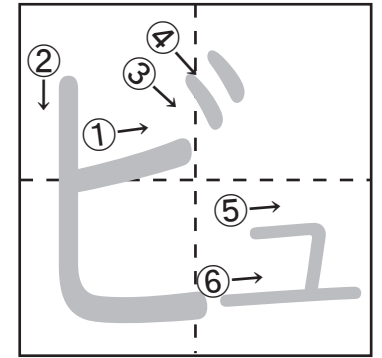

かきかた 6かく

①②③④⑤⑥のじゅんばん
でかきましょう

ひらがな

の

れんしゅう

を

しゅりゅう。

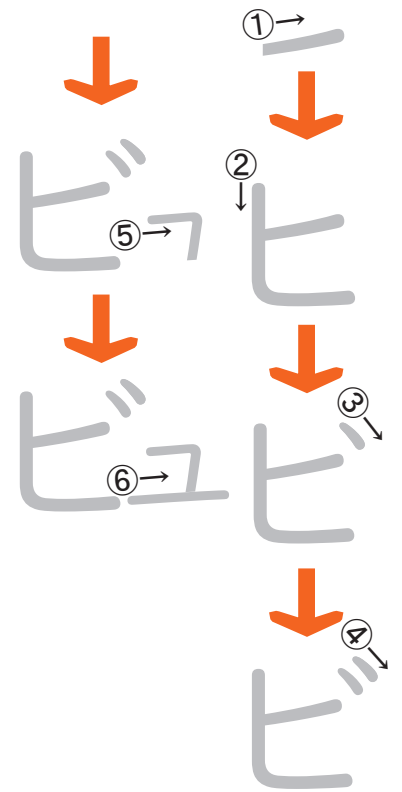

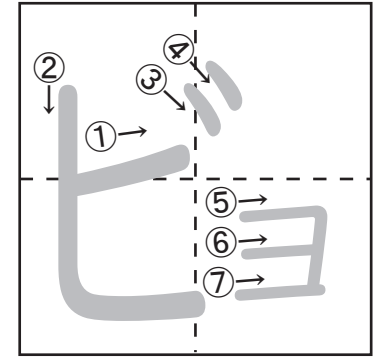
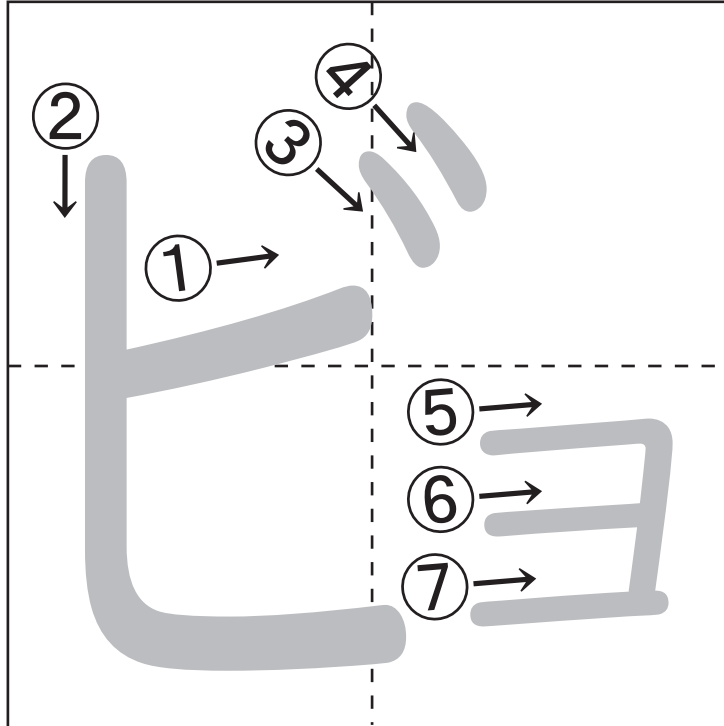
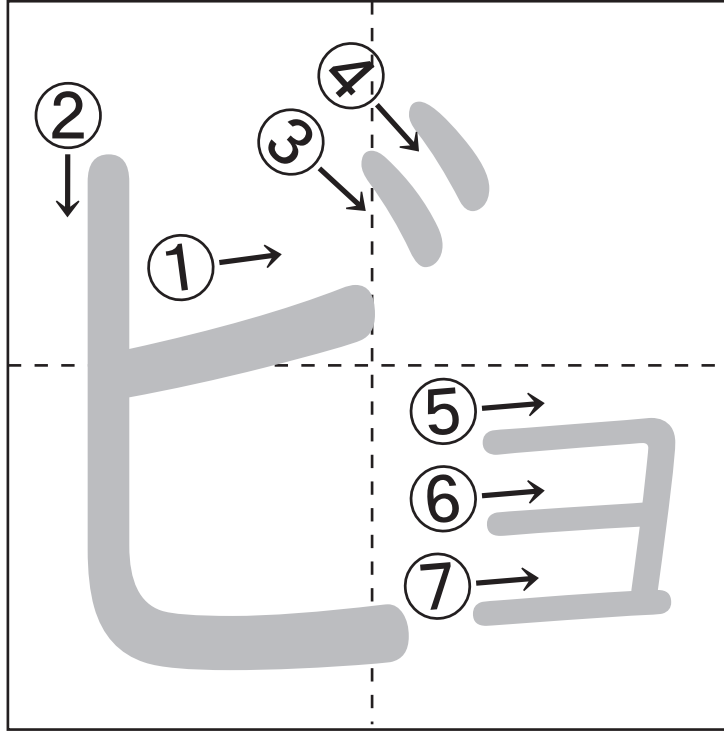
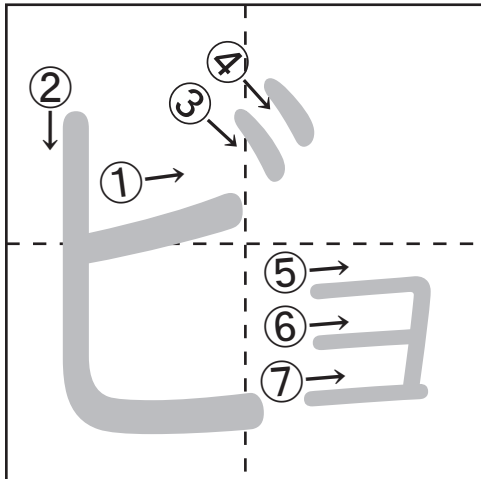
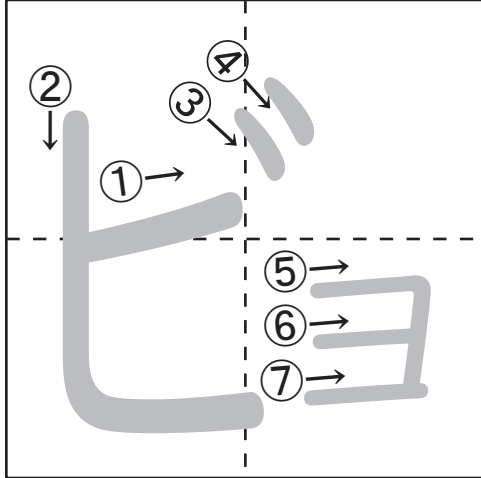
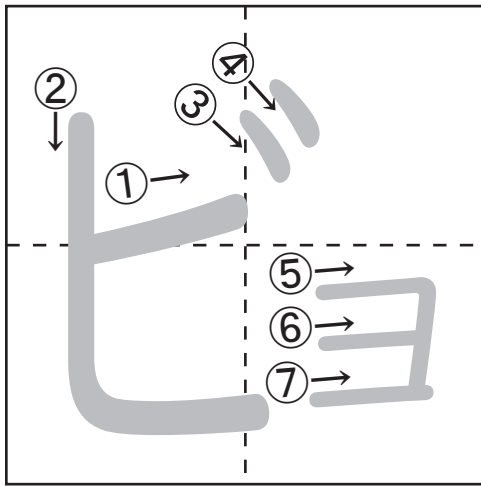
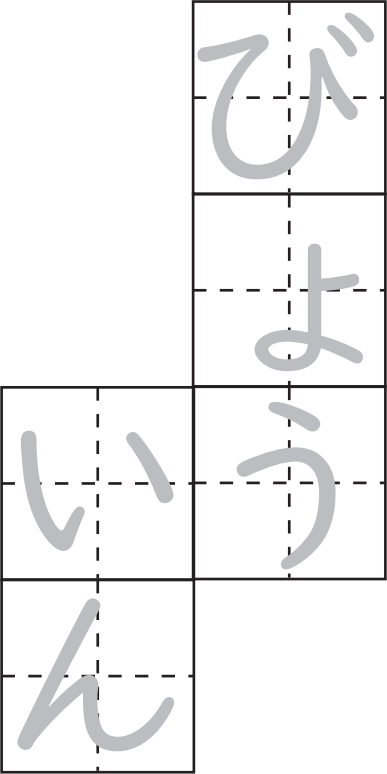
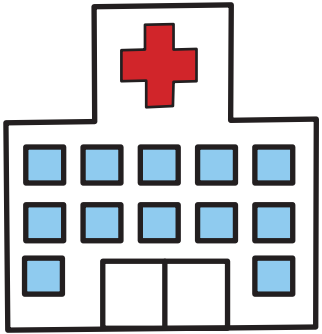

かきかた 7かく

①②③④⑤⑥⑦の
じゅんばんでかきましょう

ひらがな

の

れんしゅう

を

しゅう。

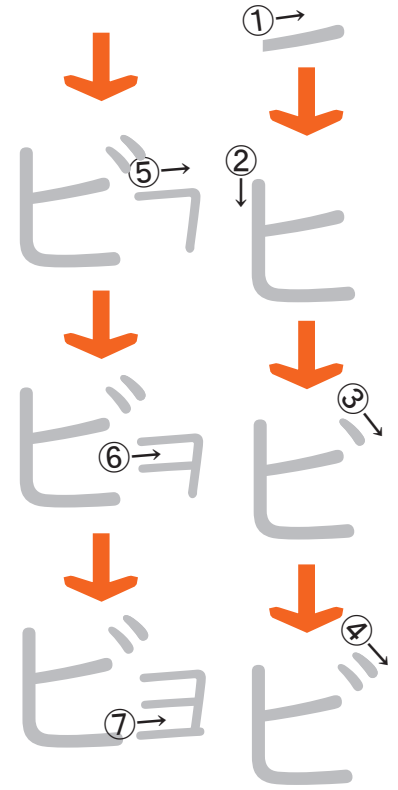

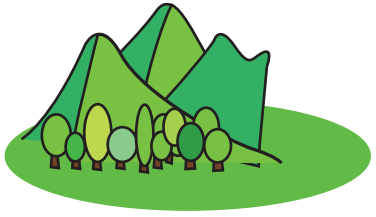

サ
シ
ヤ
ヒ

ク

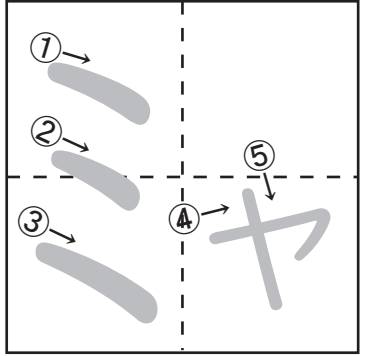
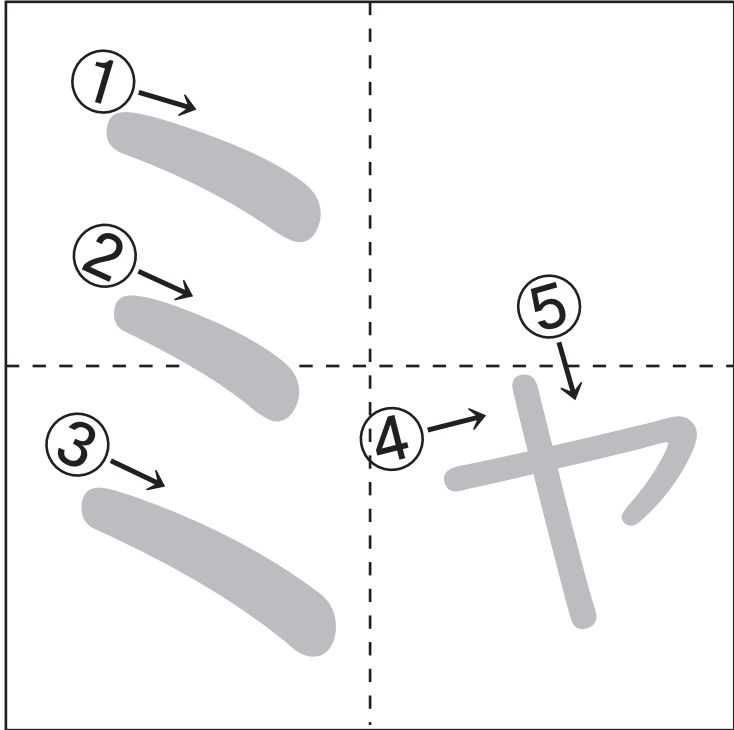
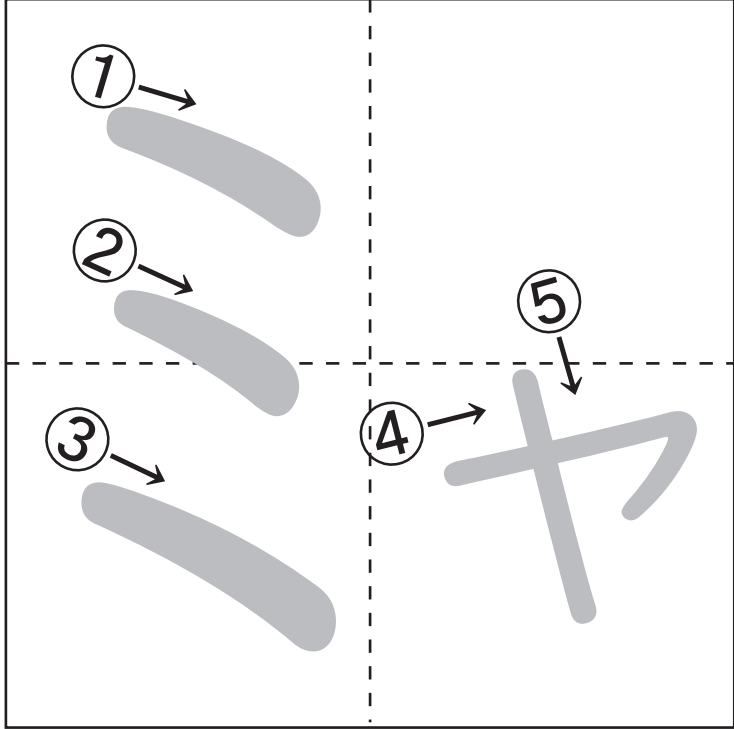
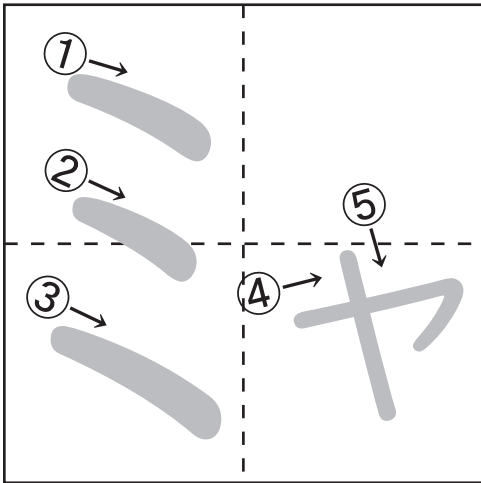
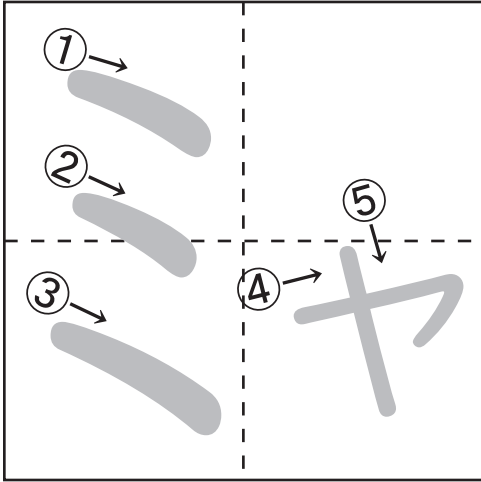
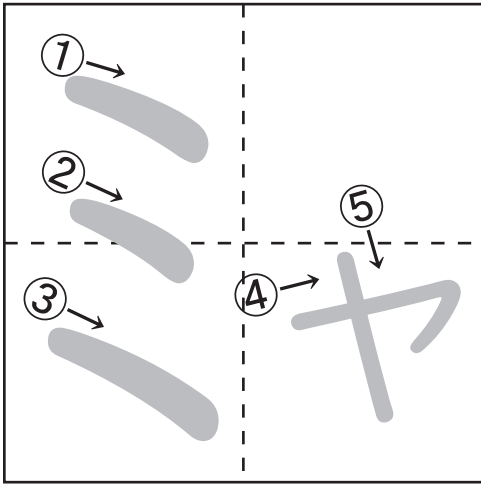

かきかた 5かく

①②③④⑤のじゅんばんで
かきましょう

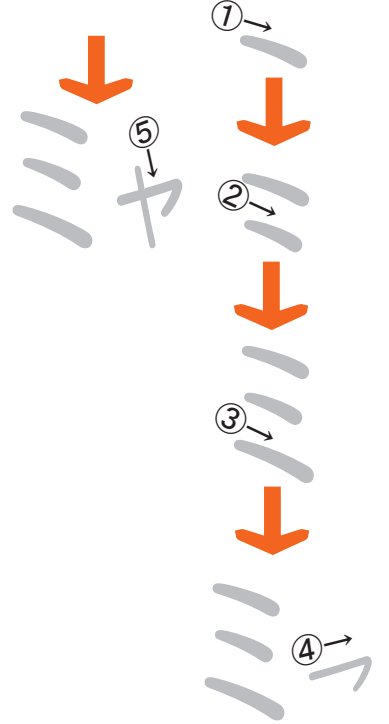

ひらがな
の
れんしゅう
を
しよ。。

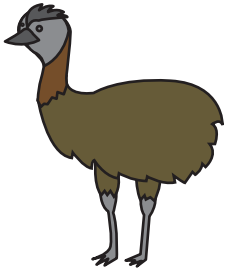

エ
ニ
ユ
一

① → ニ	④ → ⑤ → ユ
----------	-----------------

① → ニ	④ → ⑤ → ユ
----------	-----------------

① → ニ	④ → ⑤ → ユ
----------	-----------------

① → ニ	④ → ⑤ → ユ
----------	-----------------

① → ニ	④ → ⑤ → ユ
----------	-----------------

① → ニ	④ → ⑤ → ユ
----------	-----------------

かきかた 5かく

①②③④⑤のじゅんばんで
かきましょう

ひらがな
の
れんしゅう
を
しよび。

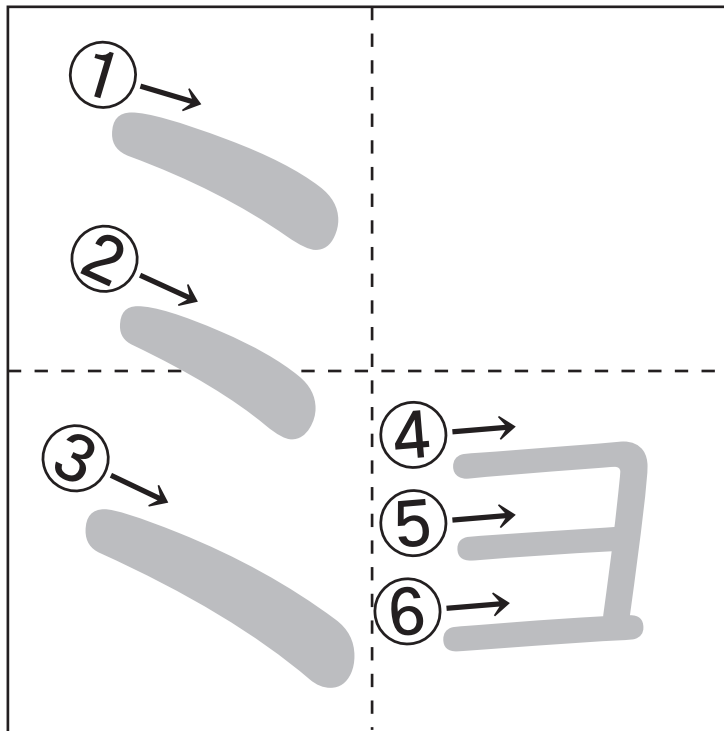
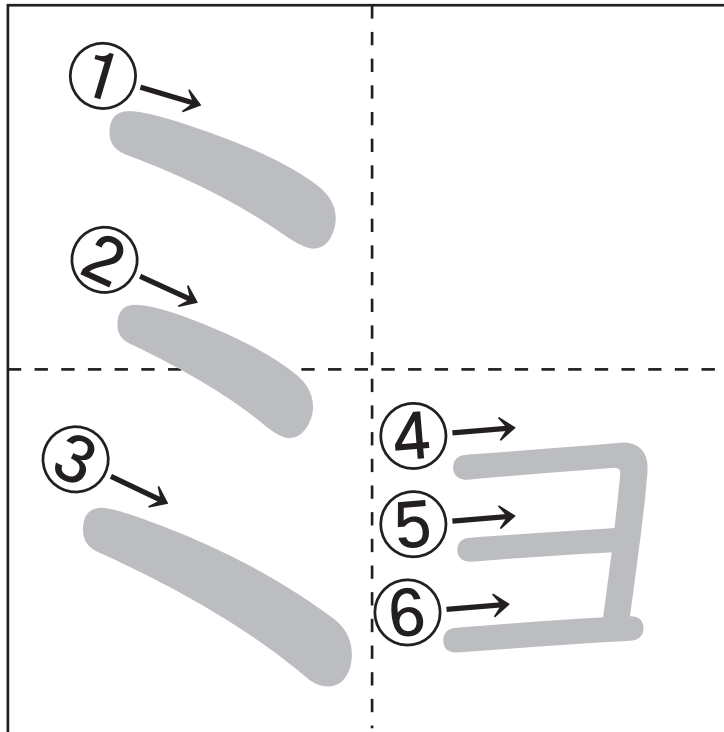
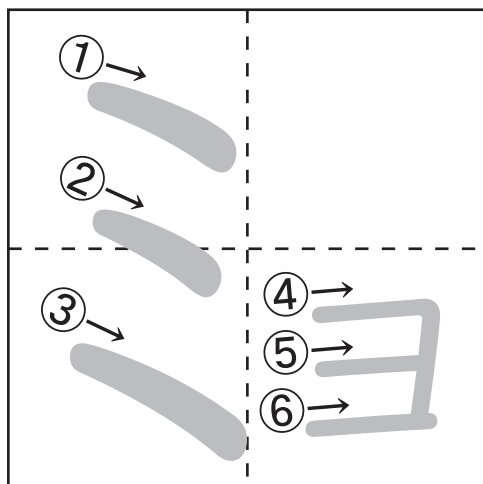
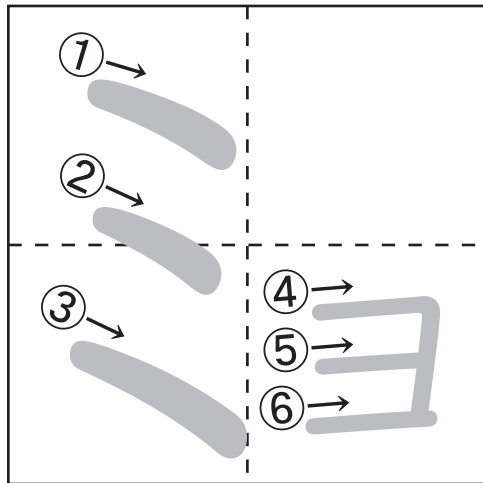
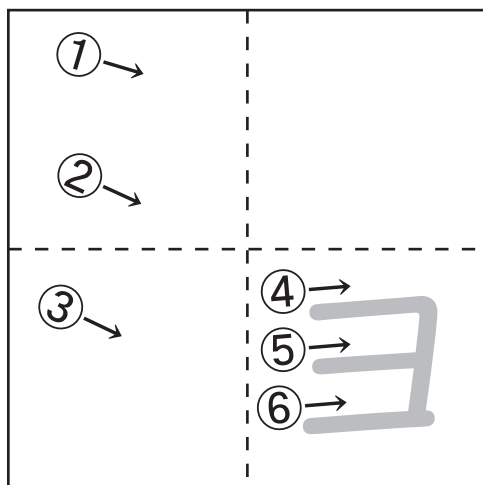
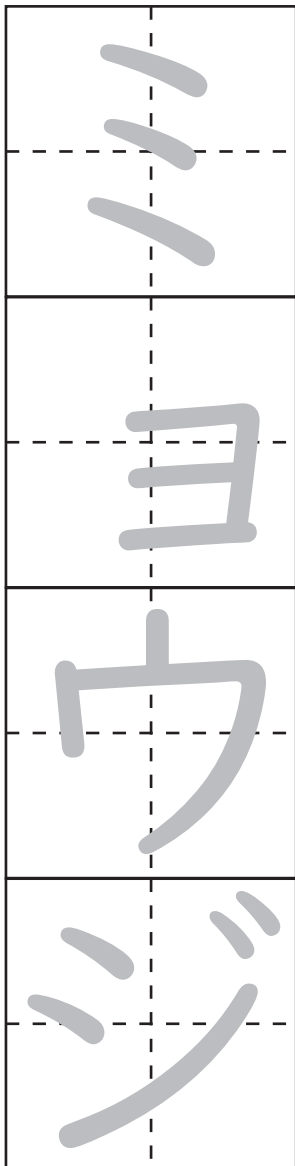

ひらがな
の
れんしゅう
を
しよ。。

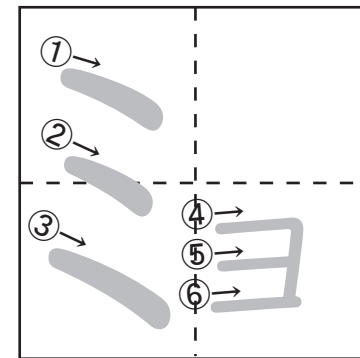

かきかた 6かく

①②③④⑤⑥のじゅんばん
でかきましょう

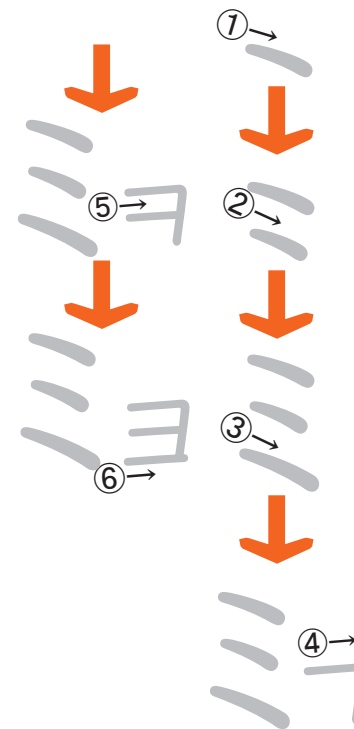

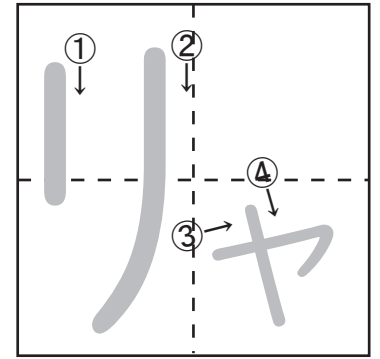
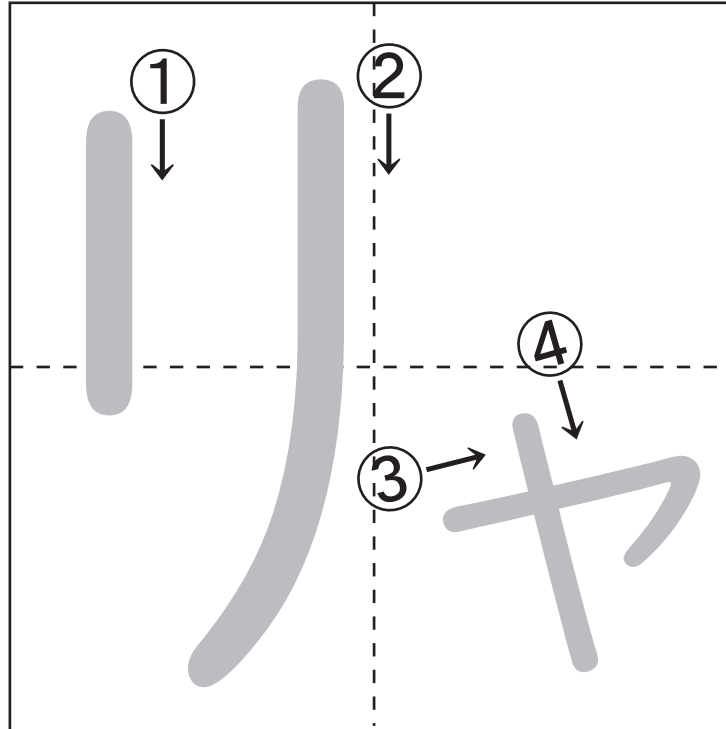
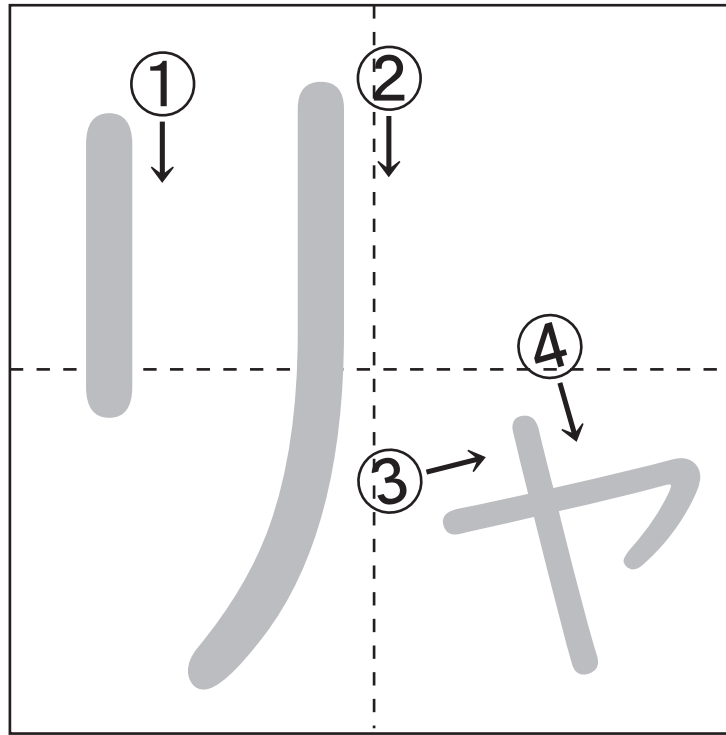
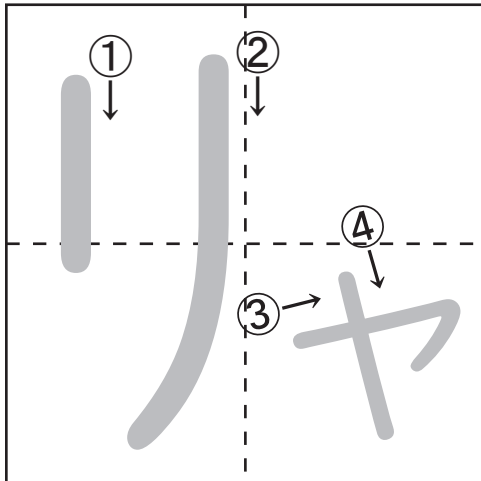
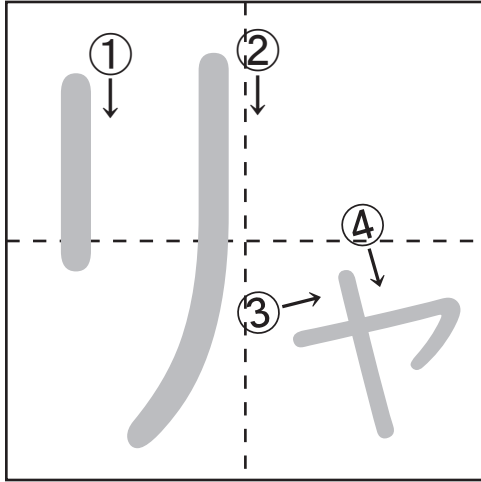
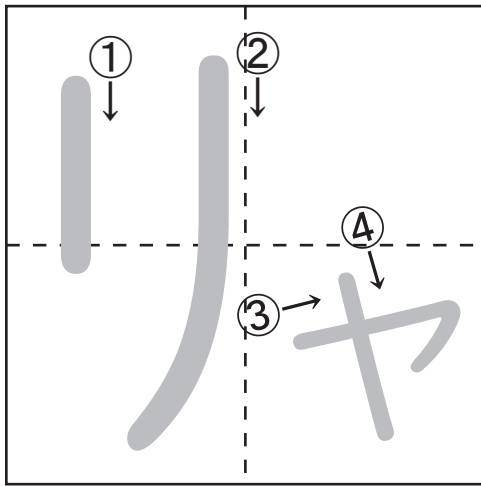
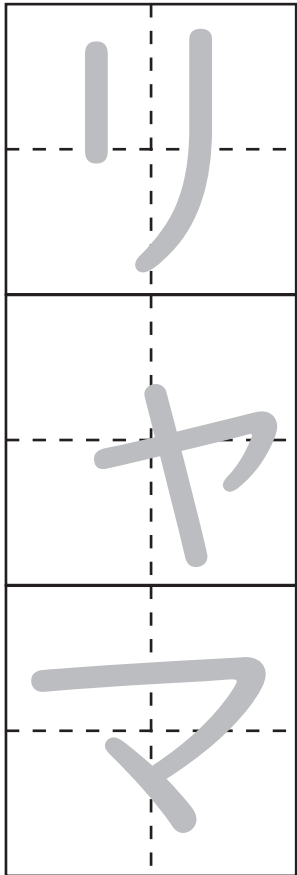
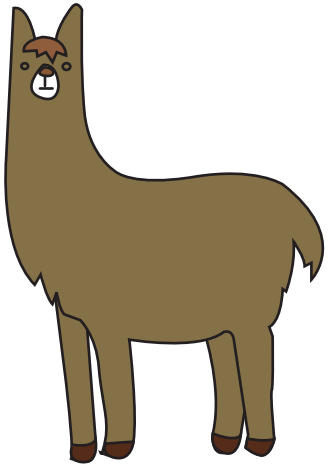

かきかた 4かく
①②③④のじゅんばんで
かきましょう

ひらがなの
れんしゅうを
しよ。。

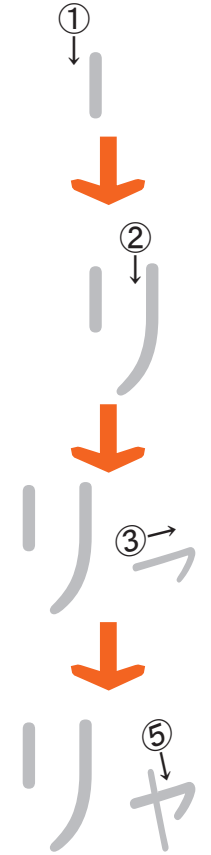

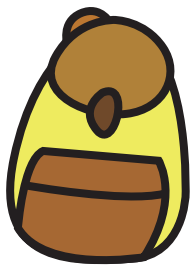

リ
ユ
ツ
ク

かきかた 4かく

①②③④のじゅんばんで
かきましょう

ひらがなの
の
れんしゅう
を
しよび。

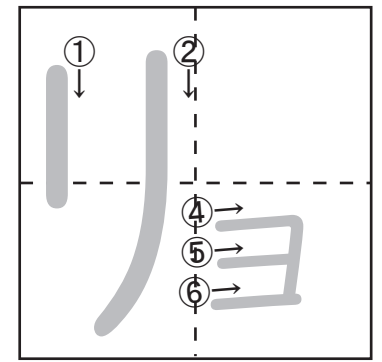
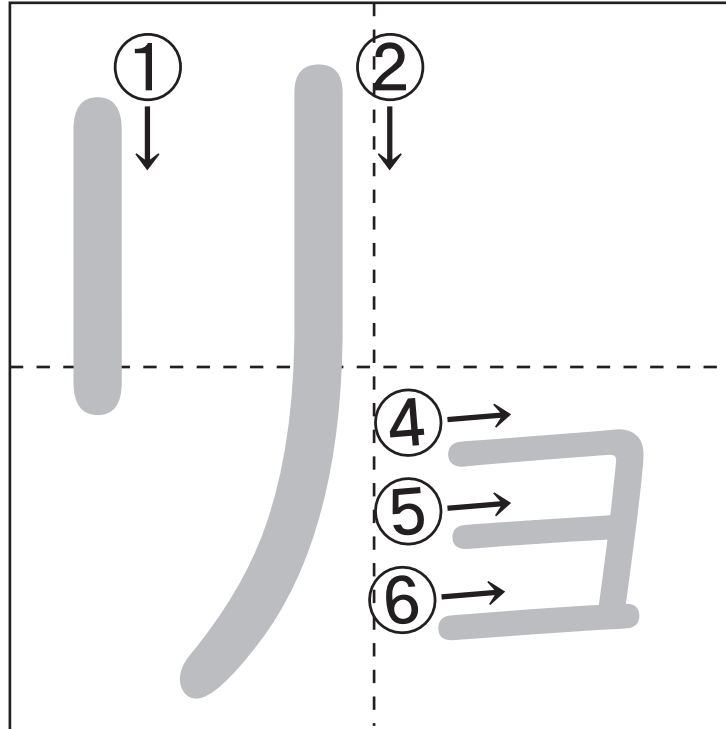
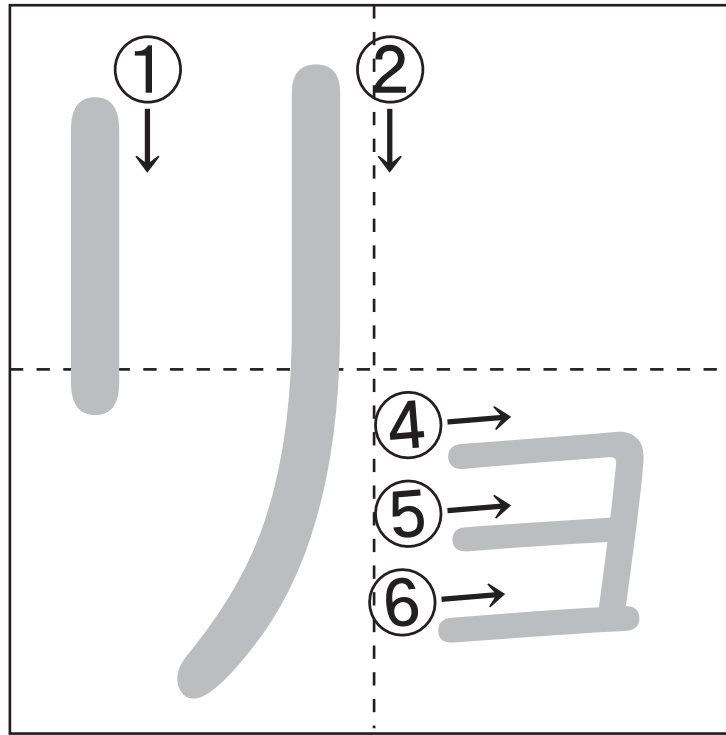
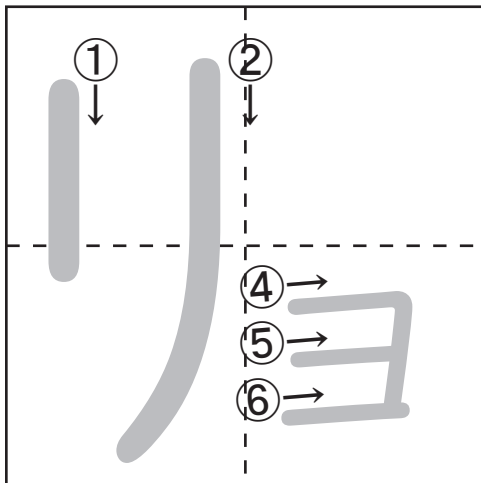
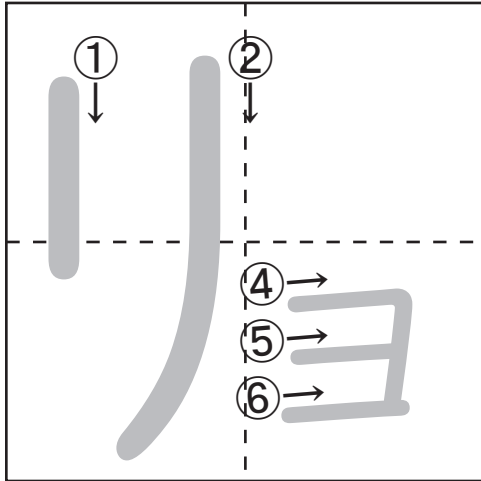
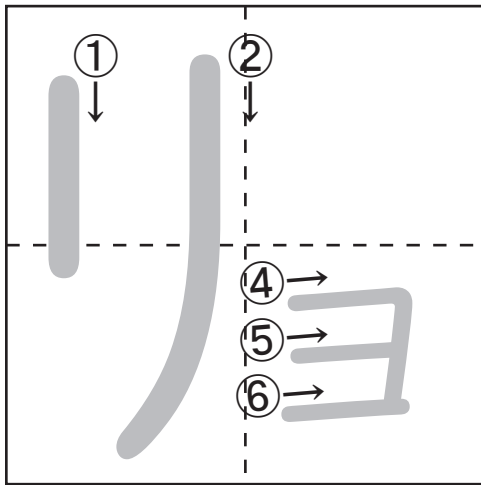
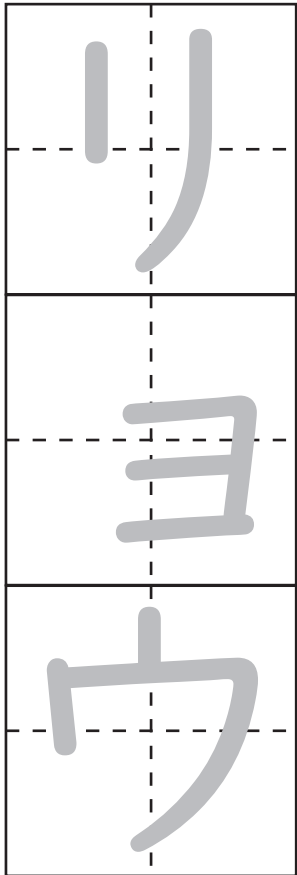
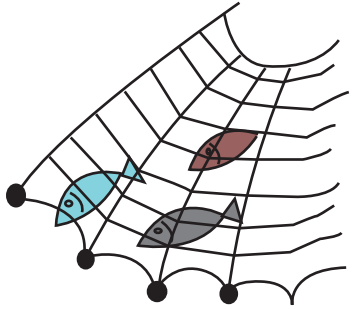

かきかた 5かく

①②③④⑤のじゅんばんで
かきましょう

ひらがなの
の
れんしゅう
を
しよび。

